

LS C&S Busduct System

I-series

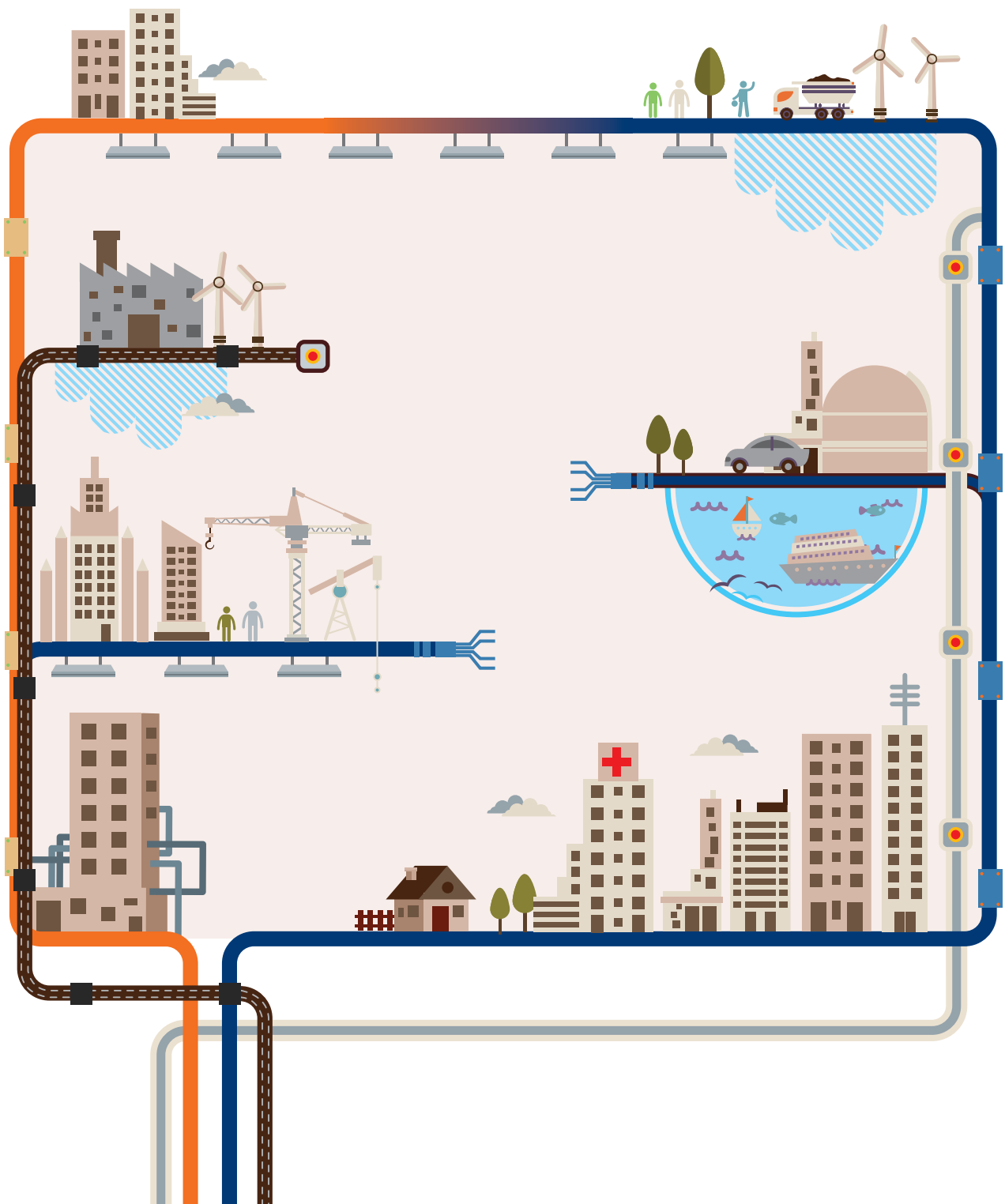

About LS Cable & System

LS spun off from LG in 2003 as a group specializing in the Electrics, Electronics, Energy, and Material. LS consists of about 40 affiliates including LS Cable & System, LSIS, LS-Nikko Copper, LS Mtron, Gaon Cable, E1 and Yesco. A leading player in the global cable industry, with over half a century of experience as a manufacturer, providing consolidated expertise in the design and production of premium quality cabling technologies.



Total Solution Provider for Electric Power and Telecommunication Industries

LS Cable & System, the longtime de facto holding company of LS Group, officially transformed into a holding company in July of 2008. The company's operations now encompass a total solution for electric power and telecommunication industries.

The latest change in corporate structure comes as the company is accelerating efforts to improve management efficiency in rapidly expanding markets. The move also results from efforts to effect a more responsible and transparent management structure. Management is now prepared to take more aggressive action to enhance our businesses and to identify new growth engines. The holding company will take the lead in fostering new growth engines and in identifying lucrative investment opportunities, while the company's other business units will focus on improving management and on making operations more efficient. With the continued support of the holding company, LS Cable & System will spearhead efforts to strengthen our business expertise, corporate competitiveness and management.



LNG, CNG



Supply of LPG for residential&commercial, transportation, industrial and petrochemical uses in domestic market. Import & Export of LPG etc.

LS Mtron



Components, Machinery

LS-Nikko Copper



Electrolytic Copper Cathode, Gold, Silver, Chemicals Product etc.

GBON



Control Cable, Power Cable, Elevator Cable, etc

Enable the Cabled World!!

LS Cable & System, established in 1962, has been contributing to building power grids and communication networks first in Korea and then in countries all over the world by developing, producing and providing cables and related solutions used in daily life and throughout many industries. Furthermore, the company set the stage for industrial and economic development by capitalizing on our innovative technology to supply various special industrial cables and industrial materials.

We at LS Cable & System are now supplying state-of-the-art products, such as submarine, extra-high voltage, high temperature superconducting and communications cables to power authorities, heavy electric equipment makers and common carriers around the world. Our products can be seen throughout the Americas, Europe, the Middle East and Asia, so we are now recognized as a leading manufacturer serving global industries both in name and reality.

Based on our corporate philosophy, "LS Cable & System Way," we will go beyond simply generating profits to develop forward thinking competencies by innovating our business models, developing environment-friendly high-quality products and reinforcing our partnerships with stakeholders as the best partner that will maximize customer values. We will open a brighter future by innovating and investing in technologies that push the envelope and developing the best total solutions.



LS Cable & System
Leading Solution

LS Cable & System Busduct System Solution



Buildings

The LS C&S Busduct system is easy to install, and ensures large capacity of energy transmission while providing space efficiency which makes the bus duct system ideal for high-rise buildings, office buildings, data centers and apartment complexes.



Plants

The full lineup consists of NSPB, CAST RESIN and SIB that can cover up to 27kV, and the lineup thus enables us to provide our clients customized designs. The system is suitable for electrical rooms and power lines, and it features a real-time monitoring system using the temperature and power monitoring system.



Data Center

The flexibility and expandability as well as easy maintenance property of the busduct system provides the best alternative to improve the existing problems of the conventional power cable system of data centers, which requires constant extension, reinstallation and capacity modification of loads.



Apartment Buildings

Although the demands for more electricity for families are growing, the space for EPS area has reduced. Due to the change, the need for busducts and multi boxes have increased.



Hospitals

The stability of the power supply in the hospitals is perhaps the most vital element, because its failure could threaten the safety of patients.

The Busduct system distributes larger capacity of electric power, and provides stability of the loads which make it an ideal choice to satisfy the requirements of systematization of hospital complexes and larger hospital equipments.



Airports

In order to secure the stable power supply of the airport, the busduct system provides the best customized solutions by installing high voltage busducts at the transmission, transformation and power distribution lines, and by installing low voltage busducts at the cargo, the control tower and general commercial buildings.



Stadiums

The needs for a busducts system has been growing for its benefit such as large capacity of power transmission, providing a stable power supply for various loads and an eco friendly property as well as economical quality.



Marine & Wind

The compact and light weight design of the busduct satisfies the demands of the clients, and comes with an outstanding quack resistance property. The busduct provides stability to the operation of the facilities through a real-time monitoring system using a temperature and power monitoring system. As the needs for renewable energy grows, the demand for our busduct has been increasing steadily.

LS Cable & System Busduct Product Line-up

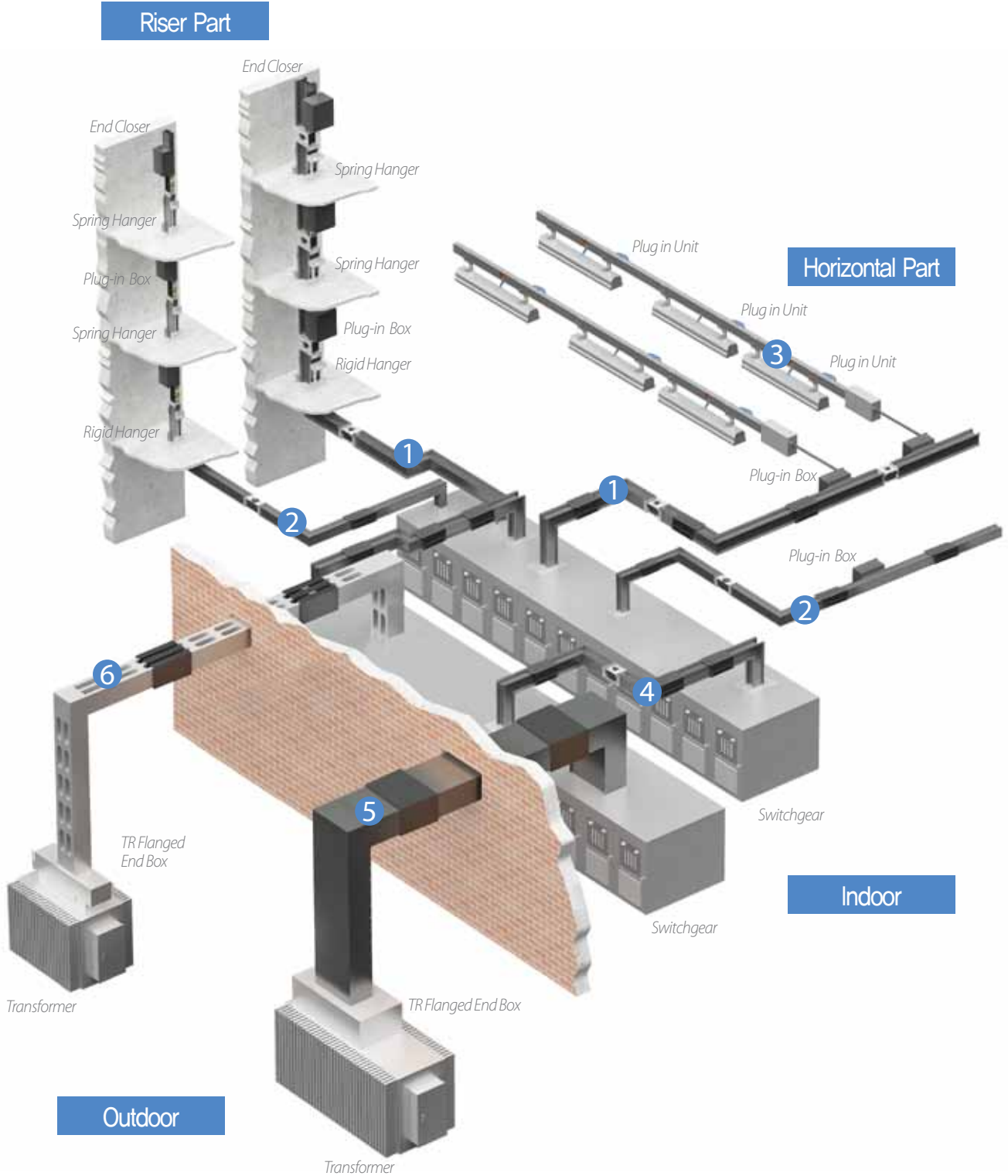

The LS Cable & System Busducts are available in a wide range of products from low current capacity LT-way (25A~63A) to large current capacity (630A~6300A), and the products enable the supply of proper capacity of power for factories and the distribution system. Our products such as the air insulated bus conducts with enhanced safety property and the cast resin busducts with resistance for high temperature, humidity and dusty environment will satisfy various application needs and provide a customized engineering service.

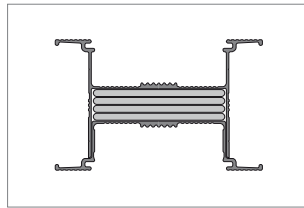
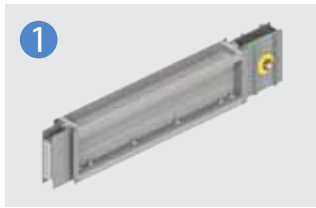

Iz/Ix/If-way

Sandwich Type (PET Film, Epoxy Coating, MICA)/AL Extrusion Housing/Standard IP54/Joint Kit

- Designed for low voltage products below AC 1000V, and between 630A to 6300A.
- The most widely used conventional model.

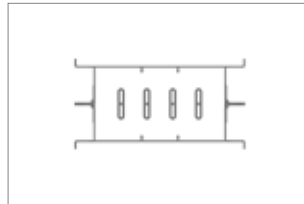
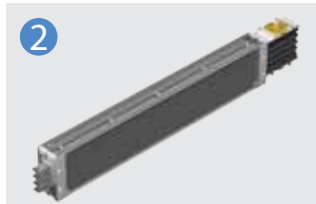

Mini-way

Air Insulated Type/AL Extrusion Housing/Standard IP54/Joint Kit

- Designed for low voltage products below AC 1000V, and between 160A and 800A.
- Ideal for small distribution system with multi distribution loads (Vertical areas of buildings, data centers, assemble factories)

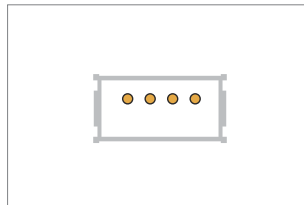

LT-way

Flat Wire Type/Copper Conductor with PVC Extruded Insulation/AL Extrusion Housing/Various Plug Types/Joint Brush (It can be installed with a live wire.)

- Designed for low voltage products below AC 690V, and between 25A and 63A
- Suitable for Light bulbs, FFU and distribution for small equipments

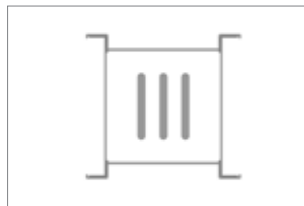

MS/Wind-way

Air Insulated Type/ Compact NSPB Type / One-Bolting Type Designed for low voltage products below AC 1000V, and between 1000A and 5000A

- A Hybrid incorporating NSPB and sandwich type
- Ideal for ships, wind towers and chemical plants where stability is required.

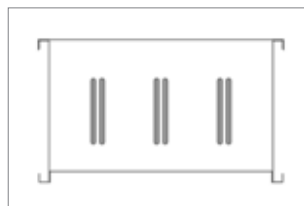

NSPB-LV/MV

Air Insulated Type/Insulated conductors separated by phase/AL, STS and Steel Housing (optional)/Indoor Type/Outdoor Type

- NSPB-LV : Designed for low voltage products below AC 1000V, and below 4000A
- NSPB-MV: Designed for high voltage products below AC 27KV, and below 4000A
- Suitable for plants where high stability is required.

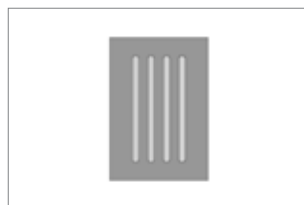

CR-LV/MV

- Cast Resin Type/IP 68/Epoxy Molding between Conductors

- CR-LV: Designed for low voltage products below AC 1000V, and between 630A and 6300A.
- CR-MV: Designed for high voltage products below AC 27KV, and below 5000A.
- The most safe bus duct suitable for plants where high stability is required.

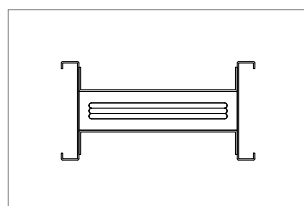

CR-LV-II

- Cast Resin Type/IP 68/Epoxy Molding between Conductors and Housing

- AL Housing(Steel and SUS as optional)/Indoor/Outdoor
- Designed for low voltage products below AC 1000V, and between 630A and 6300A.
- Suitable for area with high humidity or rapidly changing temperature
- Easily jointed with Sandwich type Busduct

Why Busduct?

Easy Distribution of Loads

When supplying power using cables, each load has to be connected individually to cables which waste space, and an additional distribution panel is also required.

On the other hand, busducts are separated from a single line at a plug box which simplifies the electric power system. A MCCB can be installed at the plug box to effectively shut off fault current.

Cable Wiring System

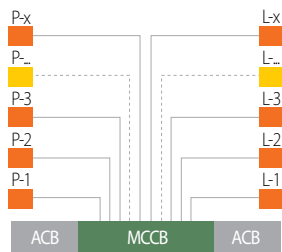

- One-to-one correspondence of power supply and loads
- Additional lines are needed in case of a load change

Busduct Wiring System

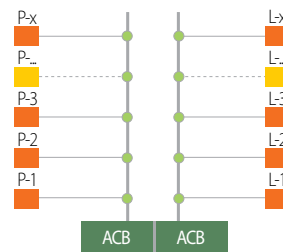

- One-to-many correspondence of power supply for specific power supply
- Additional lines are not necessary in case of a load change

ACB : Air Circuit Breaker, MCCB : Molded Case Circuit Breaker

Easy Installation

Pulling and cable tray installation for cables can be difficult, and requires a longer construction period, therefore increases the cost. On the other hand, the busducts use a simple installation method to connect specific length of products, which requires a shorter installation period, and is economically friendly.

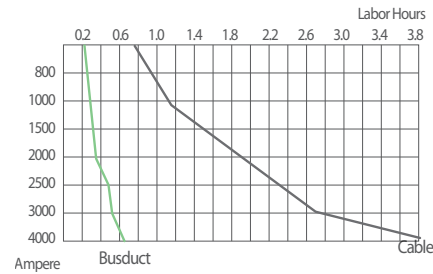

Compact

The compact design of the busduct system provides high space efficiency at up to 50% compared to the cables. While cables require larger space to install multi lines as well as additional space for coiling areas, the busducts use proper fittings to maximize space efficiency.

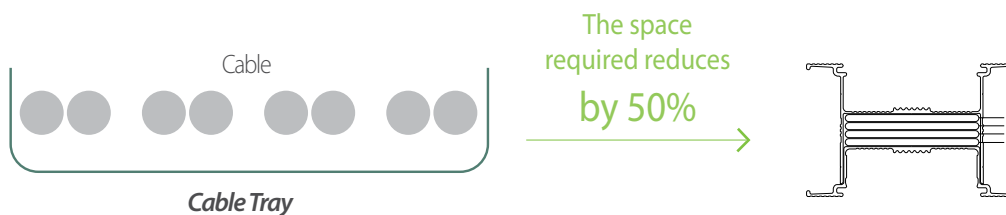

Adaptability to various installation environment with convenience

The busduct system is a power distribution system and can be applied to various complex routes. The busduct system comes with various fittings such as elbow, off-set and tee, and can transmit high capacity currents without electrical and mechanical loss.

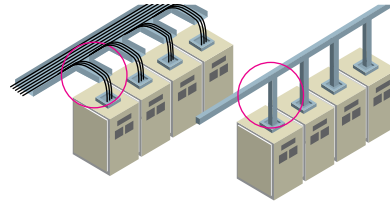

Excellent short circuit strength

The busduct system has a high tolerance for short circuit. Its stability and reliability make it perfect for a high capacity energy transmission system.

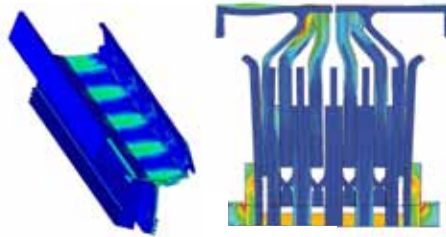

High current density

Cables are connected directly to electric loads using racks. Its maximum allowable current ampacity limit is 1000A, and requires additional lines for a higher current. Each line of the busduct system can transmit up to 6300A, and provides high current density.

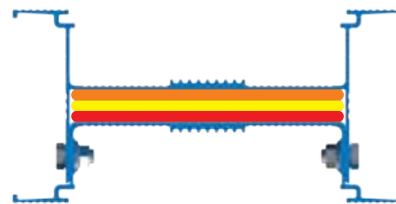

Easy maintenance

The design of the busduct system makes it easy to detect abnormalities during installations, and ensures easy maintenance. When humidity or dust causes a malfunction on the system, the easy-to-maintain design allows replacing only the damaged part.

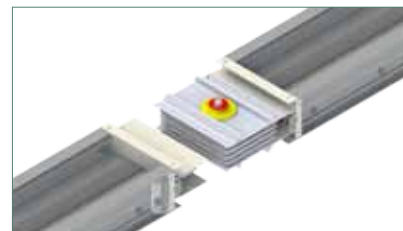

Outstanding features of EMC and EMI

Unlike cables, the busduct system does not require a shield, instead Busduct, the housing itself performs as a shield which enhances the features of EMC and EMI.



Why LS Cable & System Busduct

Global Top Tier

LS Cable & System has been a long-time leading Busduct provider in Korea. With extensive experience and product line competitiveness, the company provides total solutions for each application to satisfy the needs of its clients. Using its expertise in the electronic markets of large LCD monitors and semiconductors in Korea, the company has obtained PJT sales records in 50 countries worldwide in Asia, the Middle East, CIS, and America.

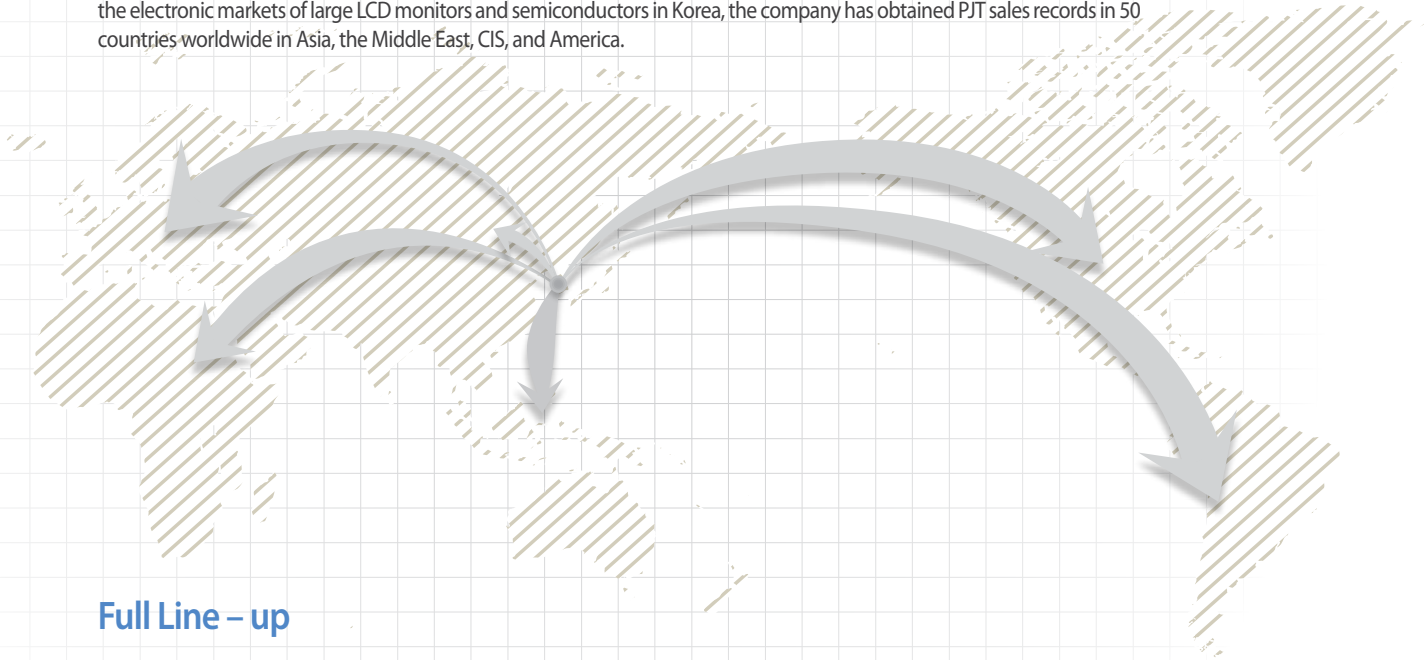

Full Line – up

LS Cable & System is the only global company that provides a full line-up of busducts, from low to high voltage and from low to high capacity, to satisfy every need of its clients and provide an optimized solution for each PJT.

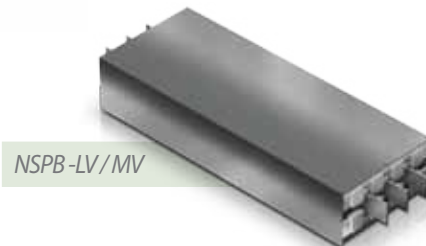
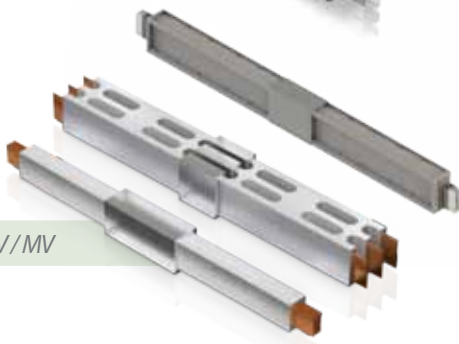
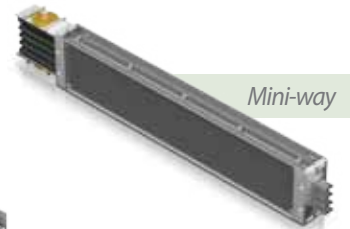

Total Solution

- Once PJT launches, our engineer will participate to guide the clients from the initial period in order to produce the best system for our clients, and to respond quickly when the system is changed.
- Our engineers from each department provide full support in design, production, installation and testing at in-bound to satisfy our clients.
- We operate the CS Team, a task force for the busduct system, to make sure efficient after-sale service and maintenance service.

Process

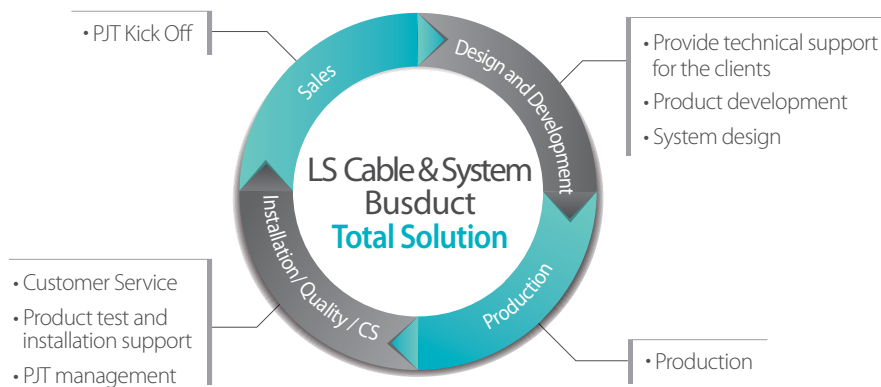

Technical Excellence

Unparalleled Reliability

- Provides standardized design, and owns numerous certifications such as UL Certification, Quack Proof Certification, and Impact Resistance Certification
- The CS team, a task force for the busduct system, provides efficient after-sale service
- Safe use in hazardous zones
- Manage the system using a unique temperature monitor sensor
- Semi-permanent service life
- Used qualified insulation such as epoxy and PET film for efficient insulation

Eco friendly

- Fully recyclable
- Halogen free
- Does not contain RoHS 6 hazardous substance
- No toxicity in fire & Fire-Retardant
- Non Explosive

Total Engineering Technology

- Provide the optimal design by experienced engineers
- Design following analysis and inspection of CAE
- Unique and exclusive design program for the busduct system
- Design based on structure stability inspection
- The excellent heat –radiating property of the aluminum housing, which ensures large capacity of power transmission
- Low Weight & Low cost
- Easy installation
- Deployable where access is difficult
- Automated epoxy insulation facility
- Unique joint kit connections
- Reduce electromagnetic
- BPMS (Busduct Power Monitoring system)
- BTMS (Busduct Temperature Monitoring system)

The Busduct Temperature Monitoring System (BTMS : Busduct Temperature Monitoring System)

The busduct is a large capacity power distribution system. The insulation of the duct has to stay stable when the Joule lines occur during a power supply of the conductor. The rated current will be set by the insulation type and the temperature rises. These properties of the busduct make it possible to monitor and manage abnormalities of the system by checking the temperature of specific areas of the system.

The temperature monitoring system uses various temperature sensors such as optical fiber cable, IC electric chips and thermo-graphic cameras. Specific areas like the entire system line, joints, plug-in boxes and cable connection can be monitored at the central monitor room using various methods on request.

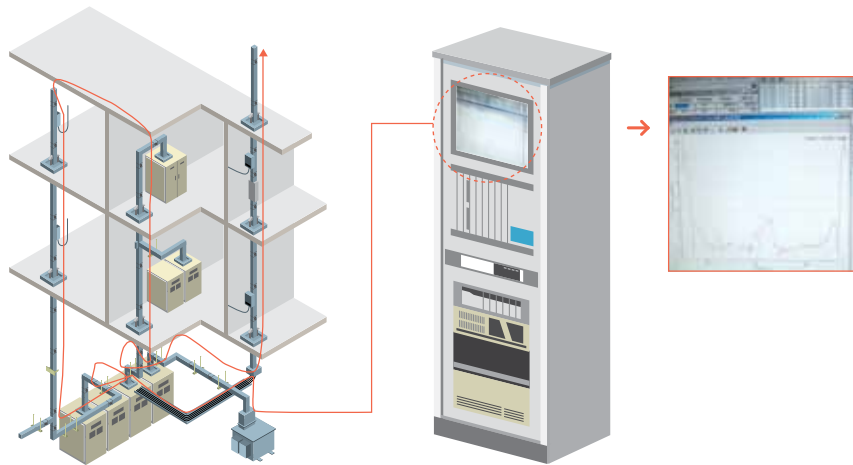

The Busduct Power Monitoring System (BPMS : Busduct Power Monitoring System)

The ongoing trends of the busduct system are more than a simple power supplying system. The growing trend is; 1) the stability of the power system, 2) unmanned system, 3) cost cutting, and 4) green and smart grid. While the SCADA system monitors and controls the power of the main system, the BMS monitors low loads of the sub system. The frequency of the recent electrical accidents is higher at the sub system than at the main system. Therefore, the preference for the BMS system has been increasing.

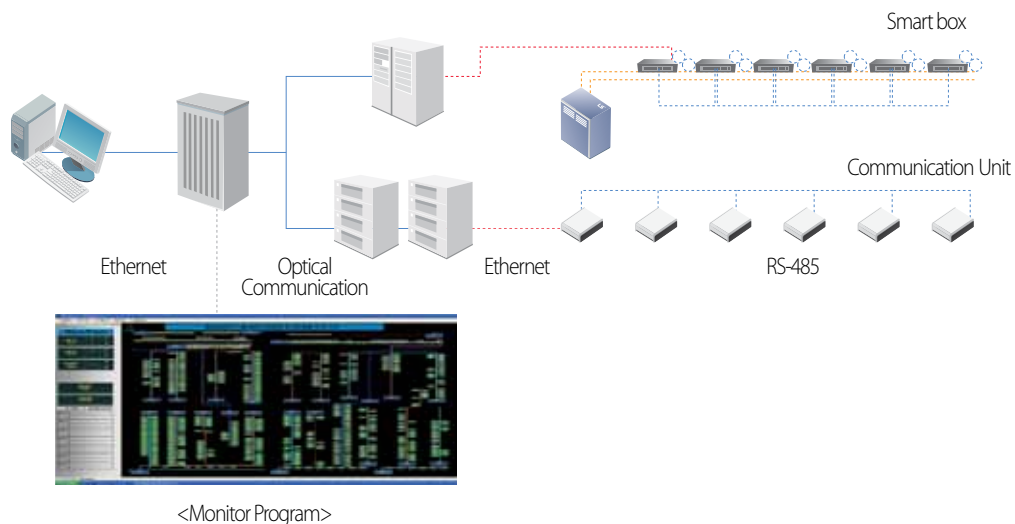

Iz/Ix/If-way

LS C&S Busbuct System Catalogue

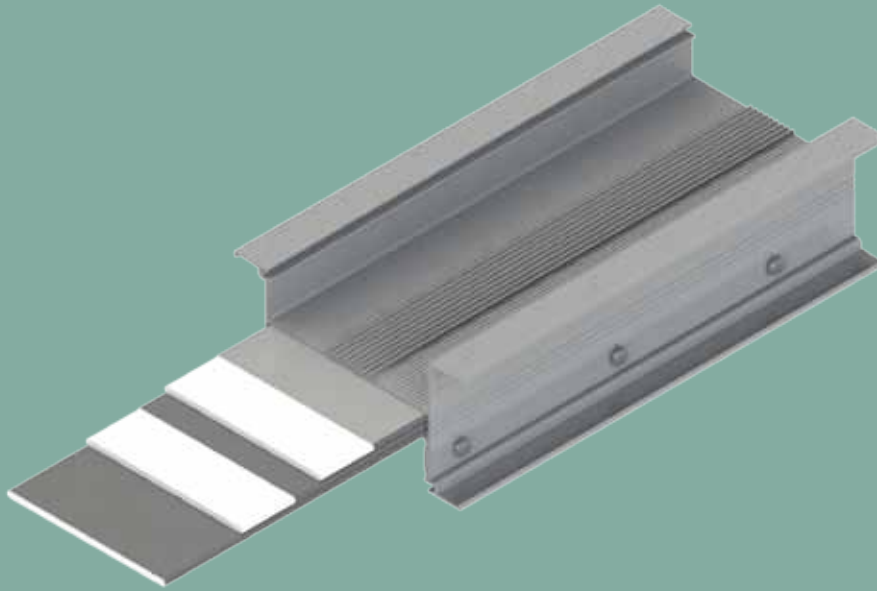

Contents

I. Introduction	
- Overview	14
- Application	15
II. General Data	16
III. Component	
- Feeder	22
- Flanged End	23
- Fittings	26
- Hanger	29
- Plug-In Unit	31
- Etc	33
IV. Technical Data	
- Impedance	35
- Voltage Drop	35
- Temperature Rise	39
V. Install Information	
- Joint Connection	40
VI. Certification & Specification	41

Overview

The I-Series

The LS C&S I-Series Busducts are designed to carry voltage range below AC 1000V, and to carry the current range of 630A to 6300A. Joint kit connections provide more space to connect which reduce the contact resistance to its minimum while connecting products. LS C&S I-series Busduct comes with a standard IP54 rating; however, it can be upgraded to an indoor or outdoor IP65 rating on request. I-Series Busducts have three different types of insulation using polyester film, mica film, or epoxy powder.

Compact Size

LS C&S I-Series Busduct uses an effective heat radiating housing profile which allows the size of the conductors to be smaller than the existing Busduct models. The light weight of the Busduct also allows easier installation and requires less space.

Economical and Easy Installation

LS C&S I-Series Busduct uses aluminum housing and joint kit connections which enable easy installation with less time and low cost.

Easy Distribution of Loads

LS C&S I-Series Busduct can directly distribute the loads at the plug-in box using a single line, and thus simplifies the power supply system. The MCCB can be installed in the plug-in box on request to effectively shut off the faulty current.

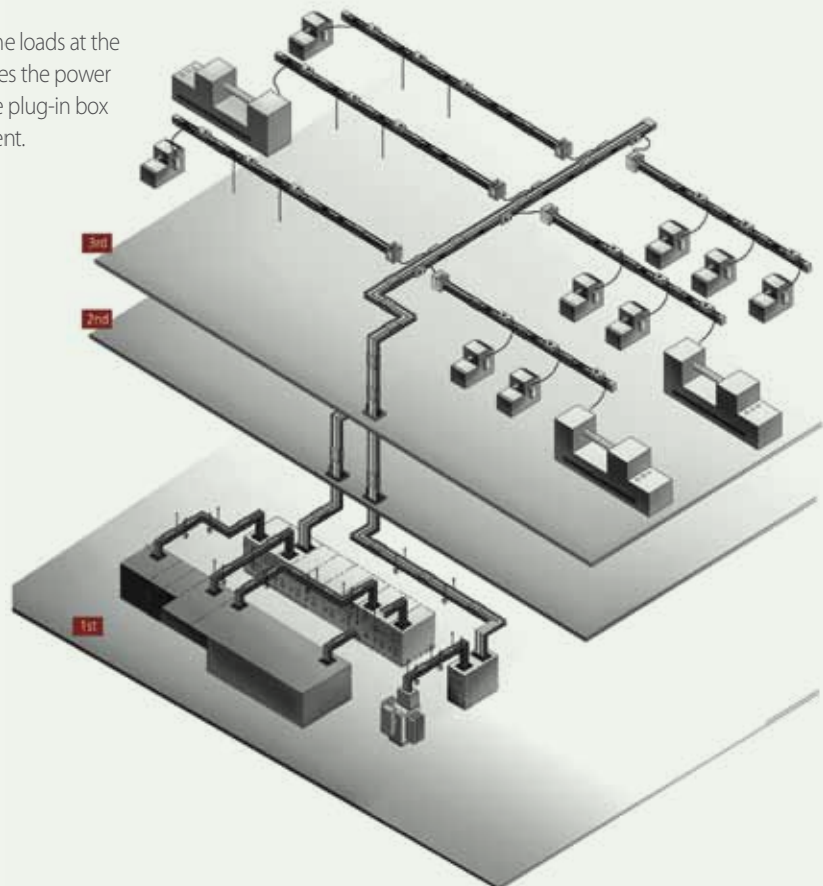

Application



Electrical Rooms

- The busduct can be installed both horizontally and vertically at the electrical room.
- The maximized safety features are seismic-proof and explosion-proof.
- Provides excellent space efficiency and easy installation compared to cables.

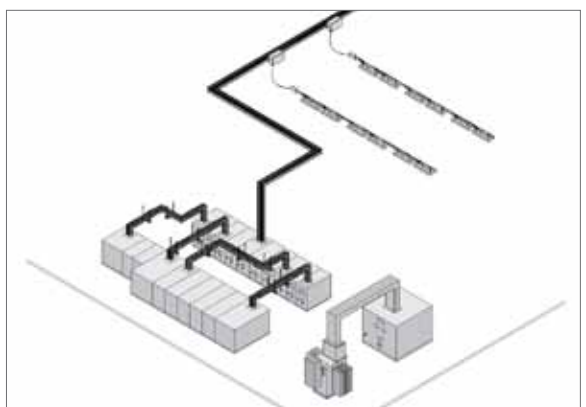

Commercial / Housing Building etc.

- Provides excellent space efficiency.
- The busducts can be applied to high-rise buildings, office buildings, and data centers.
- Multi-box can be applied on request.

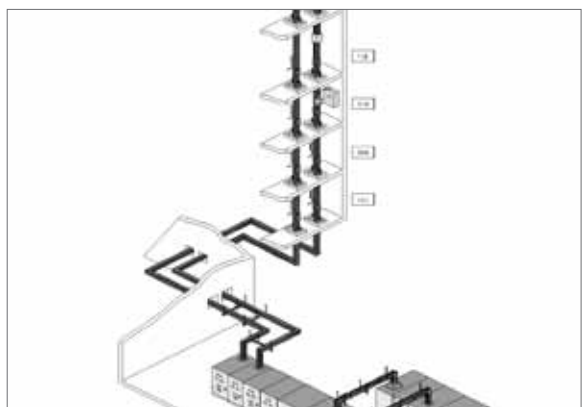

Factory / Plant etc.

- The busducts can be applied to a vast range of industries such as semiconductor, display and petrochemical plants.
- The temperature and the power supply monitoring system allows easy maintenance.
- The busducts provides high space efficiency, and allows a significantly reduced installation period.

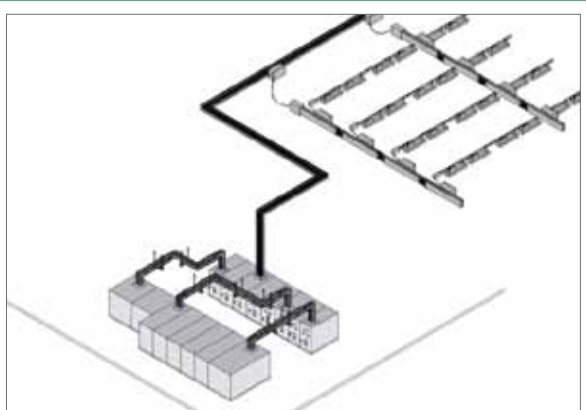

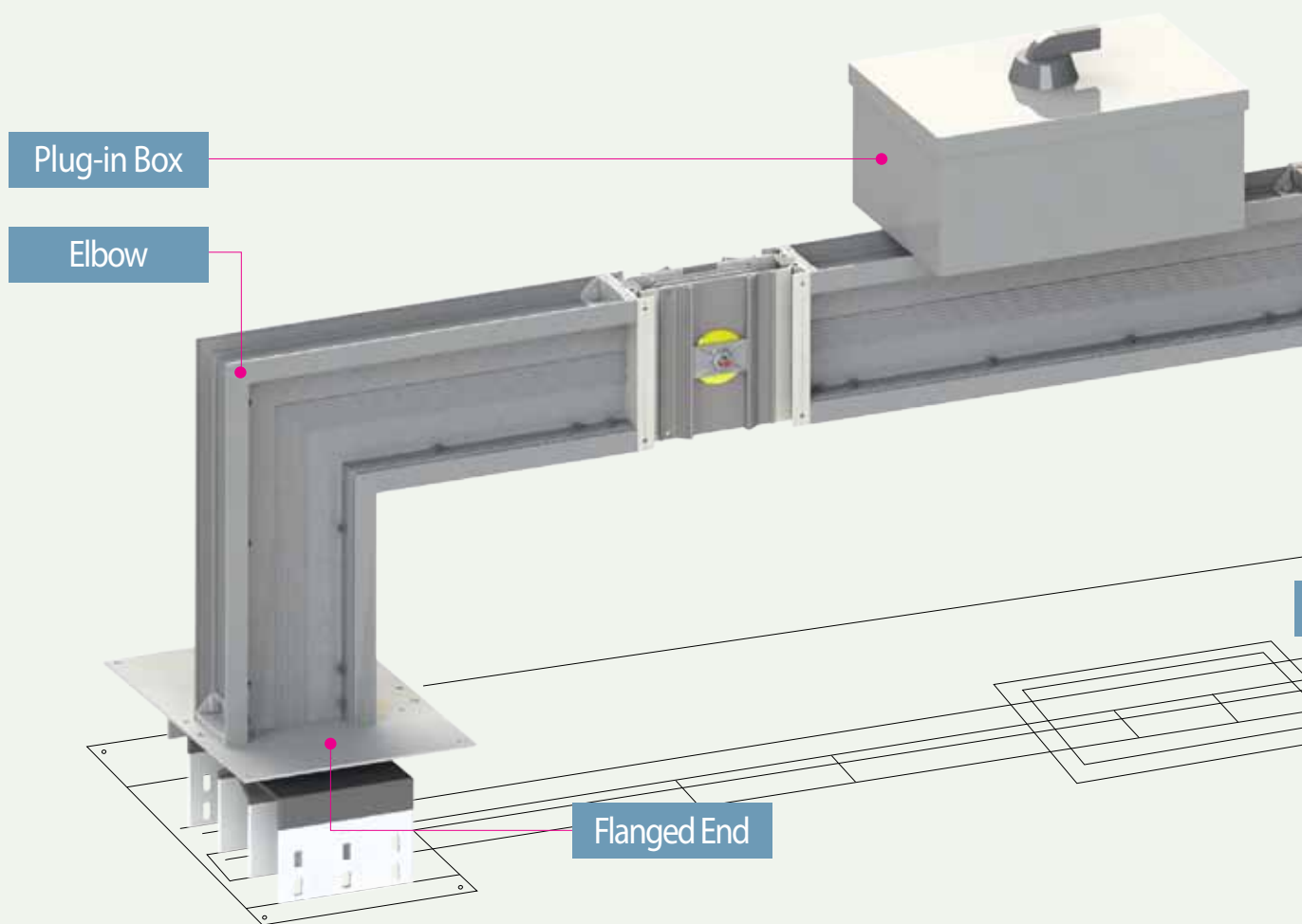

High Current Density

The busduct has a compact design compared to the existing models by using an effective heat-radiating housing profile and can carry from 630A up to 6300A with reduced loss of electric power. It is an ideal power distribution system that provides high efficiency, stability, economy-friendliness and convenience. The design of the conductor allows flexibility to extend and relocate depending on the environment.



Eco - Friendly

The LS C&S Busducts acquired RoHS certification, and only uses components without hazardous substances such as lead, cadmium, mercury, chrome, PBBs and PBDEs.



Low Voltage Drop and High Short Circuit Strength

Thanks to the optimum design, power can be transmitted with the greatest possible efficiency, and the resultant voltage drop is low due to extremely low impedance. In addition, the LS C&S Busducts is designed to have high short circuit strength. Reinforced type is available. contact our engineering staff



Standard

- IEC 61439-1 [(previous standard)IEC 60439-1] Power Switch gear and Control gear Assemblies
- IEC 61439-6 [(previous standard)IEC 60439-2] Busbar Trunking Systems
- BS EN 61439 Busways
- NEMA BU 1.1 Busways
- AS / NZS 3439.2



Permissible Operating Temperature

The cross sectional areas of the conductor and housing profile are designed to meet the standard permissible operating temperature of IEC 61439-1 and 6. Therefore the temperature rise limit of the housing is within 55K or less of the ambient temperature.



Service Condition

- Ambient Temperature : -15°C ~ 50°C
- Relative Humidity : 95% or below
(When the service condition of the environment does not meet the requirements listed above, please contact our design team.)

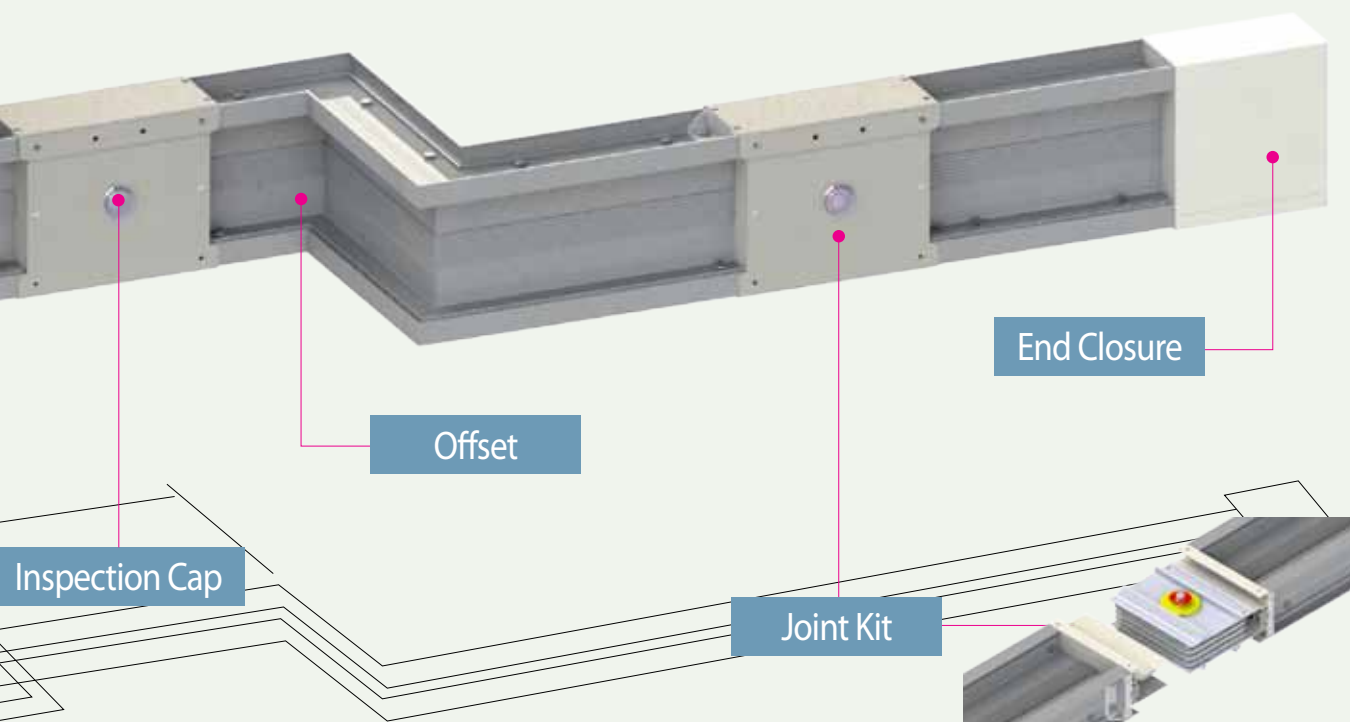

Conductors

The I-Series uses either copper conductors with conductivity over 98% and purity over 99.9%, or aluminum conductor with conductivity over 61% and purity over 99.6%

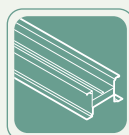

Housing

The I-Series uses an effective heat-radiating aluminum housing profile which produces an excellent mechanical strength and heat radiation. The aluminum housing can be used as a protective conductor(PE) due to its high level conductivity and cross sectional areas. An optional optical fiber temperature sensor can be installed at the housing.



Insulation Properties

An insulator of thermal class rating Class B(130°C) (Class F(155°C) optional) is applied to the I-Series. Other insulation options such as Epoxy, PET and MICA (Fire proof up to 1200°C) are also available. FRP (Fiber Reinforced Plastic) with high dielectric property is used as insulation at the connection which performs as insulation between phases and housing.



Connection

- **Kit**: DH (dual head) bolts and Visible-label (Redtag)
Check for installation using the contact
To exert a uniform force on the entire connection can Disc Spring A structure. (Assembly Torque 800 ~ 1000kgf.cm)

General Specifications

I-series Busduct uses insulation with a thermal class rating over 130°C for each phase. A sandwich type design is applied to the Busduct to protect the aluminum housing, and it can be used at the voltage range of AC 1000V or less, and the current range between 630A to 6300A. It is designed to use a joint kit connection and general IP54 rating.

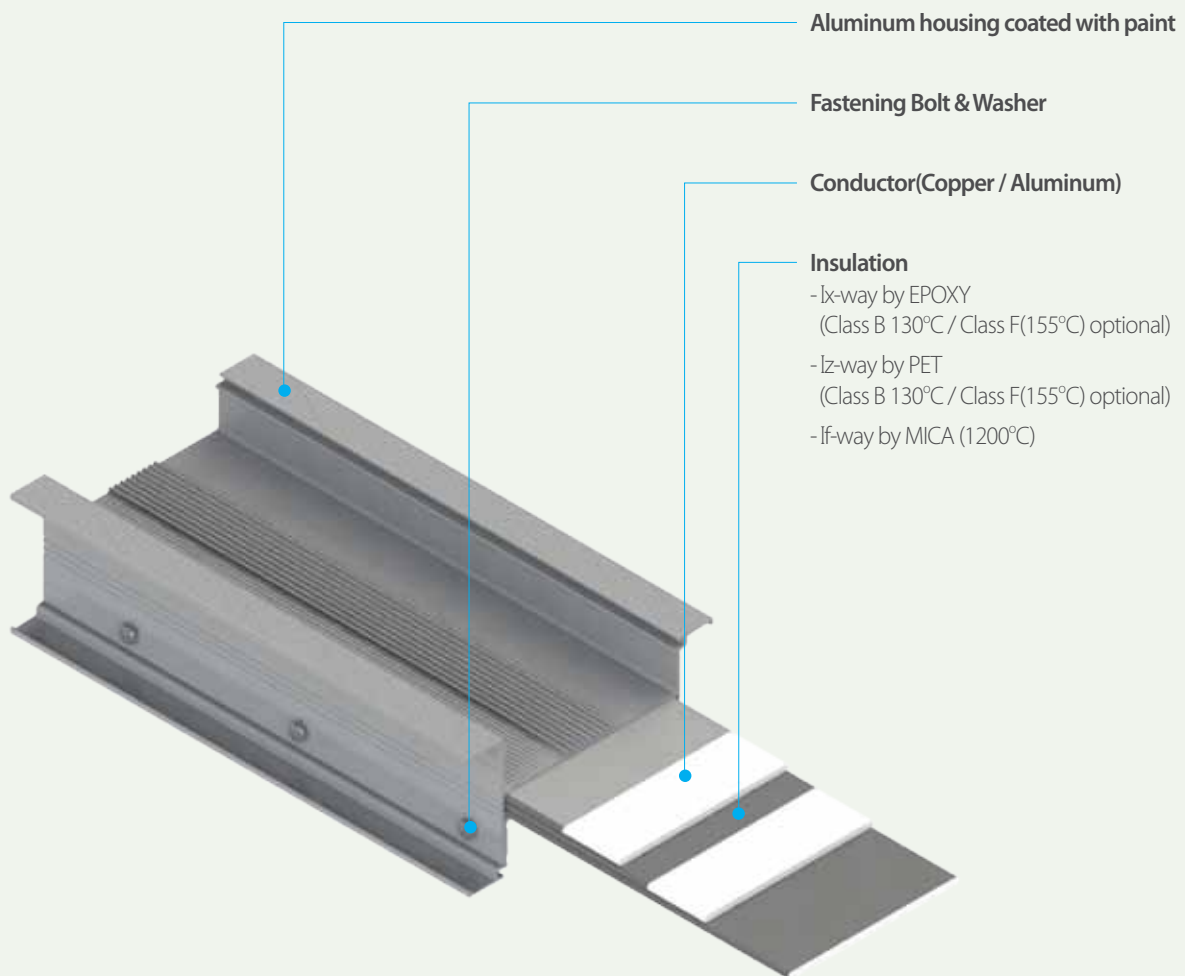

Joint Connection

Feature

Both joint plates of the joint kit and the conductors are tin plated. (A silver plated option is available.)

It prevents the joint plate from discoloration and corrosion. In order to ensure easy maintenance and reliability, double-headed bolts and visible labels are used to check the application, and a disc spring allows even connection of the contact surface.

Double Headed Bolts

Double-headed bolts are used to ensure a proper torque level when installing the joint kit.

If a torque wrench applies a pressure of 800 to 1000kgf.cm to the outer bolt head, the head of the outer bolt and the tag attached to it will be sheared off automatically.

Thus, it allows visual inspection for the proper application of the bolts at the connection.

The remaining bolt head can be re-used when tightened to 800kgf.cm using a torque wrench.

After installing joint cover, red line at the end of double headed bolt should be seen through the inspection cap.

Joint Kit

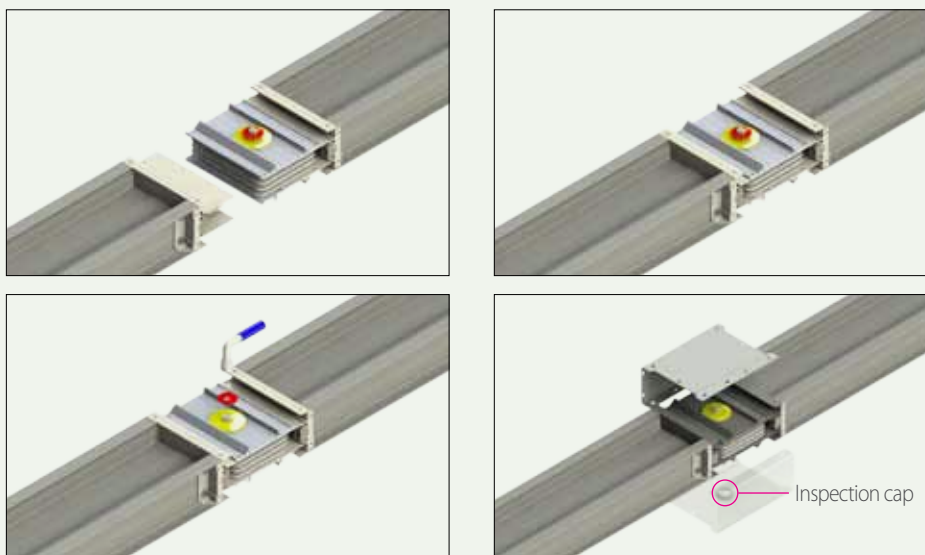

Number of Double headed bolts (60hz)

Number of D.H bolts		1	2	3	4	6
Ampere (A)	AL	630, 800, 1000, 1250, 1450, 1600	1850, 2000, 2250, 2500, 2900, 3200	-	3700, 4000, 4500	5000, 5800, 6300
	CU	630, 800, 1000, 1250, 1450, 1600, 1850, 2000	2250, 2500, 2900, 3200, 3700, 4000	5000, 5800	4500	6300

Number of Double headed bolts (50hz)

Number of D.H bolts		1	2	3	4	6
Ampere (A)	AL	630, 800, 1000, 1250, 1600	2000, 2500, 3200	5000	4000	6300
	CU	630, 800, 1000, 1250, 1600, 2000	2500, 3200, 4000	5000, 6300	-	-

! Precaution

Be sure to clean the interior of the connections prior to installation. Use caution not to twist the joint kit while inserting it, and after it is inserted.

An excessive pressure during installation may break the kit.

Make sure that the double-headed bolts and the red tags are intact.

If proper torques are not applied at the connection, it may cause heat during operation.

Grounding and Harmonics

I-Series Busduct comes with aluminum housing, and the cross-section area of the housing is over 100% of each phase conductor. Therefore, the aluminum housing alone works as 100% or more of ground bar, and the housing also improves the heat radiation of the conductors.

If increased ground capacity is required, additional internal ground bars can be added to the assembly, providing a 50% or 100% increase in ground path.

The 200% N type Busduct is used for a nonlinear load that generates harmonic current. Lately, the needs for non-linear loads at the power distribution system of buildings are increasing due to the increase of office automation and computer facilities. The harmonic current produced by the system can flow more than 100% of over current at phase N. The LS C&S 200% N type busduct is safe to be used at the distribution system where the harmonic current can be generated.

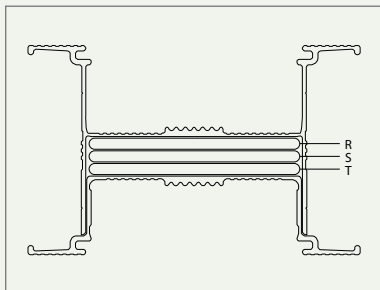

[3W+GE]

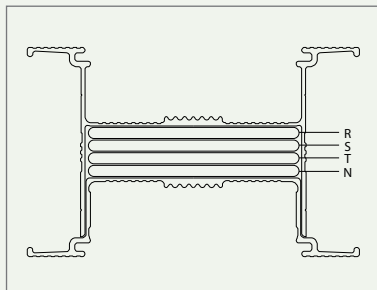

[4W+GE]

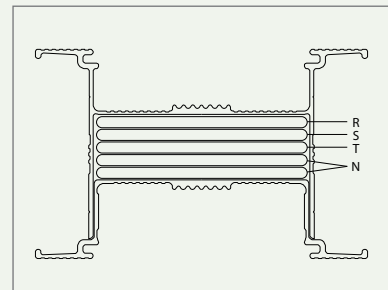

[4W(200%N)+GE]

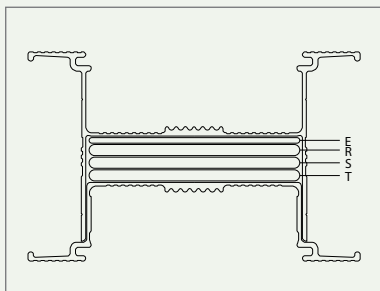

[3W+50%E, 100%E]

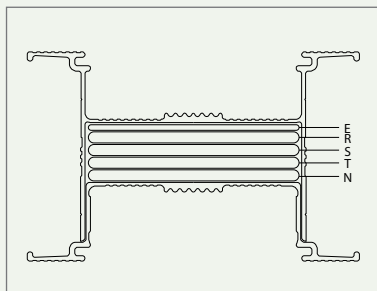

[4W+50%E, 100%E]

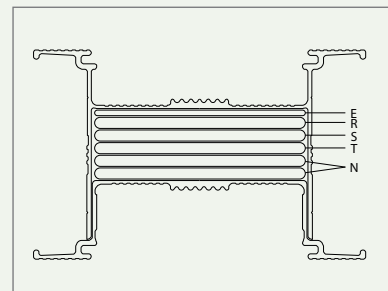

[4W(200%N) + 50%E]

Plating/Painting

Plating

Standard tin plating is applied at taps, plugs and connections of conductors using an electroplating method to maintain the electrical characteristics and to prevent corrosion. Silver plating is available on request.

Painting

In order to improve heat radiation and to prevent corrosion, as well as to fit in with the surroundings, we apply polyester-epoxy (hybrid) power coating after treating the surface. A wide range of color is available to meet the needs of our clients.

*Standard color : RAL 7032

IP Code (Degree of Protection)







International protection degree codes provided by IEC 60529(Degree of Protection Provided by Enclosure-IP Code)

NEMA STANDARD : • IP54=NEMA 12, 12K, 13 • IP55=NEMA 3, 3X, 3S, 3SX • IP66=NEMA 4,4X • IP67=NEMA 6
 * As the standard differs, it is a similar substitution, not 1:1 substitution.









The degree of protection against water of the LS C&S I-Series is a standard IP54; however, it can be adjusted from IP42 to IP65 depending on the environment and on request.

IP

Solid Particle Protection

-  **0 No Protection**
-  **1** Protection against 50mm diameter solid particles. (back of a hand)
-  **2** Protection against 12mm solid particles. (fingers)
-  **3** Protection against 2.4mm solid particles. (tools or thick wires)
-  **4** Protection against 1mm solid particles. (tools or most wires)
-  **5** Protection against dust.
-  **6** Complete protection against dust.

Liquid Ingress Protection

-  **0 No Protection**
-  **1** Protection against falling drops of water.
-  **2** Protection against falling drops of water with an enclosure tilted at a 15degree angle from a vertical line
-  **3** Protection against spray sat a 60degree angle from a vertical line
-  **4** Protection against water splashed from all directions.
-  **5** Protection against low pressure jets of water from all directions.
-  **6** Protection against strong jets of water from all directions.
-  **7** Protection against the effects of immersion between 15.0 centimeters and 1.0 meter.
-  **8** Protection against longer periods of immersion under pressure.

Degree of Protection IP54

IP54 is applied to the feeder, plug-in and tap-off, and can be used during water leakages and near sprinklers.

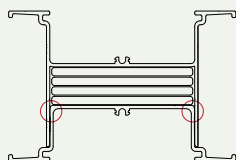

Indoor

Degree of Protection IP55/IP65 (Indoor/Outdoor)

With the IP65 rating, the busduct is ideal for corrosive environments. The special sealing between the housing sections seals off water, dust and gasses.

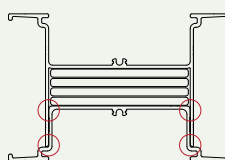

Indoor Type (IP55/65)

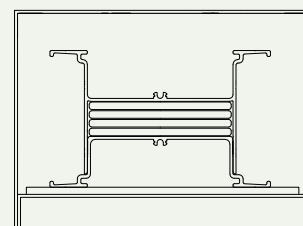

Outdoor Type (IP65)

Feeder

Sectional View

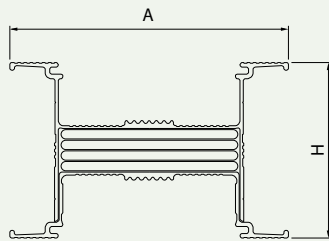

[Fig.E1-1]

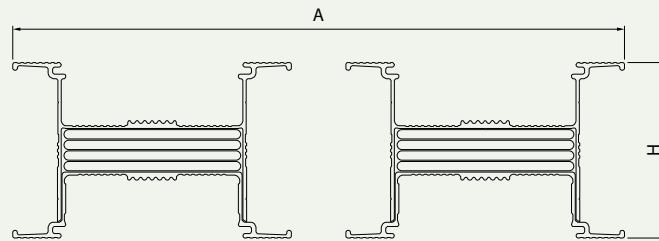

[Fig.E1-2]

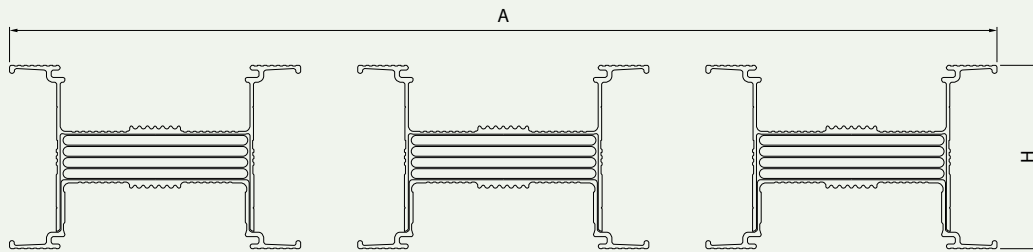

[Fig.E1-3]

AL Rating(A)		Dimension (mm)	Weight (kg/m)		CU Rating(A)		Dimension (mm)	Weight (kg/m)		Fig.
60Hz	50Hz	A	3W	4W	60Hz	50Hz	A	3W	4W	
630	630	107	6.93	7.69	630	630	112	8.75	10.45	E1-1
800	800	117	7.77	9.13	800	800	127	10.41	12.54	
1,000	1,000	137	9.37	11.26	1,000	1,000	147	12.73	15.54	
1,250	1,250	162	11.45	13.95	1,250	1,250	147	17.62	22.05	
1,450	1,600	197	14.67	17.82	1,450	1,600	167	21.32	26.85	
1,600	-	207	15.61	19.20	1,600	-	177	23.05	29.11	
1,850	2,000	242	18.43	22.67	1,850	2,000	207	28.59	36.16	
2,000	-	252	19.27	23.91	2,000	-	217	30.66	38.84	
2,250	-	277	21.28	26.38	2,250	-	237	34.16	43.40	
2,500	2,500	357	23.42	27.74	2,500	2,500	327	36.25	45.43	E1-2
2,900	3,200	427	29.89	35.55	2,900	3,200	367	43.41	54.71	
3,200	-	447	31.74	37.97	3,200	-	387	47.01	59.42	
3,700	4,000	517	37.39	44.91	3,700	4,000	447	58.41	73.96	
4,000	-	537	39.15	47.20	4,000	-	467	62.34	79.01	
4,500	-	587	43.69	53.03	4,500	-	507	70.01	89.01	E1-3
-	5,000	687	47.74	57.16	-	5,000	597	70.62	89.27	
5,000	-	747	53.12	63.77	5,000	-	642	80.44	101.61	
5,800	6,300	822	59.08	69.83	5,800	6,300	717	93.90	119.04	
6,300	-	897	65.03	75.90	6,300	-	777	104.49	132.85	

* H: 107.5(3W+GE, 3W+50%E) / 115(4W+GE, 4W+50%E) / 130(4W+100%E)

** According to IEC 61439, 5% more current can be used at a frequency of 50 Hz

Flanged End

Flanged end is connected to either a transformer or panel. Dimension details are listed below.

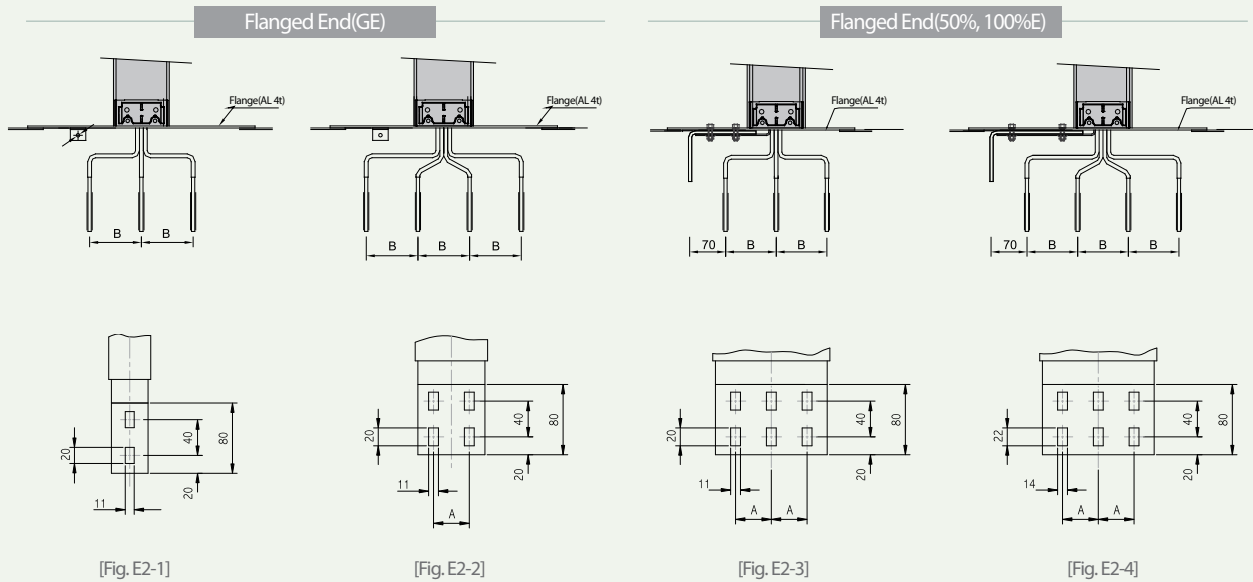

AL Rating(A)		Dimension(mm)		Fig.	CU Rating(A)		Dimension(mm)		Fig.
60Hz	50Hz	A	B		60Hz	50Hz	A	B	
630	630	-	100	E2-1	630	630	-	100	E2-1
800	800	-			800	800	-		
1,000	1,000	40		E2-2	1,000	1,000	40		E2-2
1,250	1,250	50			1,250	1,250	40		
1,450	1,600	40		E2-3	1,450	1,600	50		E2-3
1,600	-	50			1,600	-	50		
1,850	2,000	60		E2-4	1,850	2,000	50		E2-4
2,000	-	60			2,000	-	50		
2,250	-	70			2,250	-	60		
2,500	2,500	50		130	E2-2	2,500	2,500		40
2,900	3,200	40	2,900			3,200	50		
3,200	-	50	E2-3		3,200	-	50	E2-3	
3,700	4,000	60			3,700	4,000	50		
4,000	-	60	E2-4		4,000	-	50	E2-4	
4,500	-	70			4,500	-	60		
-	5,000	50	E2-3		-	5,000	50	E2-3	
5,000	-	60			5,000	-	40		
5,800	6,300	60	E2-4		5,800	6,300	50	E2-4	
6,300	-	70			6,300	-	60		

*Contact our engineering staff for more detail

Flanged End

Drilling Pattern for Flanged End

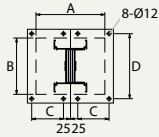

[Fig. E3-1]

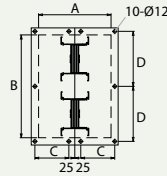

[Fig. E3-2]

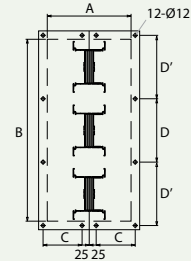

[Fig. E3-3]

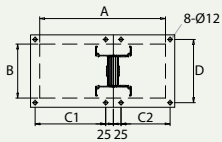

[Fig. E4-1]

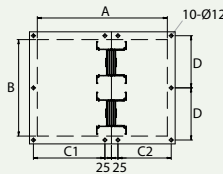

[Fig. E4-2]

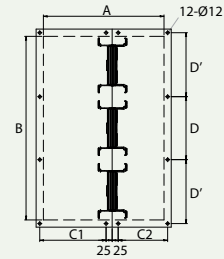

[Fig. E4-3]

Rating(A)		3WGE	3W, 4WGE	3WGE	3W, 4WGE	4WGE	3W, 4WGE	4WGE	3W, 4WGE	Fig.	4W+50%E/100%E						Fig.		
60Hz	50Hz	AL, CU	AL	AL, CU	AL	AL, CU	CU	AL, CU	CU		AL, CU	AL, CU	AL, CU	AL, CU	AL, CU	AL, CU			
		A	B	C	D	D'	A	B	C		D	D'	A	B	C1	C2		D	D'
630	630	240	121	110	151	-	340	126	160	156	-	E3-1	410	121/126	230	160	151/156	-	E4-1
800	800	240	131	110	161	-	340	141	160	171	-		410	131/141	230	160	161/171	-	
1,000	1,000	240	151	110	181	-	340	161	160	191	-		410	151/161	230	160	181/191	-	
1,250	1,250	240	176	110	206	-	340	161	160	191	-		410	176/161	230	160	206/191	-	
1,450	1,600	240	211	110	241	-	340	181	160	211	-		410	211/181	230	160	241/211	-	
1,600	-	240	221	110	251	-	340	191	160	221	-		410	221/191	230	160	251/221	-	
1,850	2,000	240	256	110	286	-	340	221	160	251	-		410	256/221	230	160	286/251	-	
2,000	-	240	266	110	296	-	340	231	160	261	-		410	266/231	230	160	296/261	-	
2,250	-	240	291	110	321	-	340	251	160	281	-		410	291/251	230	160	321/281	-	
2,500	2,500	300	371	140	200.5	-	430	341	205	185.5	-	E3-2	500	371/341	275	205	200.5/185.5	-	E4-2
2,900	3,200	300	441	140	235.5	-	430	381	205	205.5	-		500	441/381	275	205	235.5/205.5	-	
3,200	-	300	461	140	245.5	-	430	401	205	215.5	-		500	461/401	275	205	245.5/215.5	-	
3,700	4,000	300	531	140	280.5	-	430	461	205	245.5	-		500	531/461	275	205	280.5/245.5	-	
4,000	-	300	551	140	290.5	-	430	481	205	255.5	-		500	551/481	275	205	290.5/255.5	-	
4,500	-	300	601	140	315.5	-	430	521	205	275.5	-		500	601/521	275	205	315.5/275.5	-	
	5,000	300	701	140	241	245	430	611	205	211	215	E3-3	500	701/611	275	205	241/211	245/215	E4-3
5,000	-	300	761	140	261	265	430	656	205	226	230		500	761/656	275	205	261/226	265/230	
5,800	6,300	300	836	140	286	290	430	731	205	251	255		500	836/731	275	205	286/251	290/255	
6,300	-	300	911	140	311	315	430	791	205	271	275		500	911/791	275	205	311/271	315/275	

Flanged End Box / Feed in Box

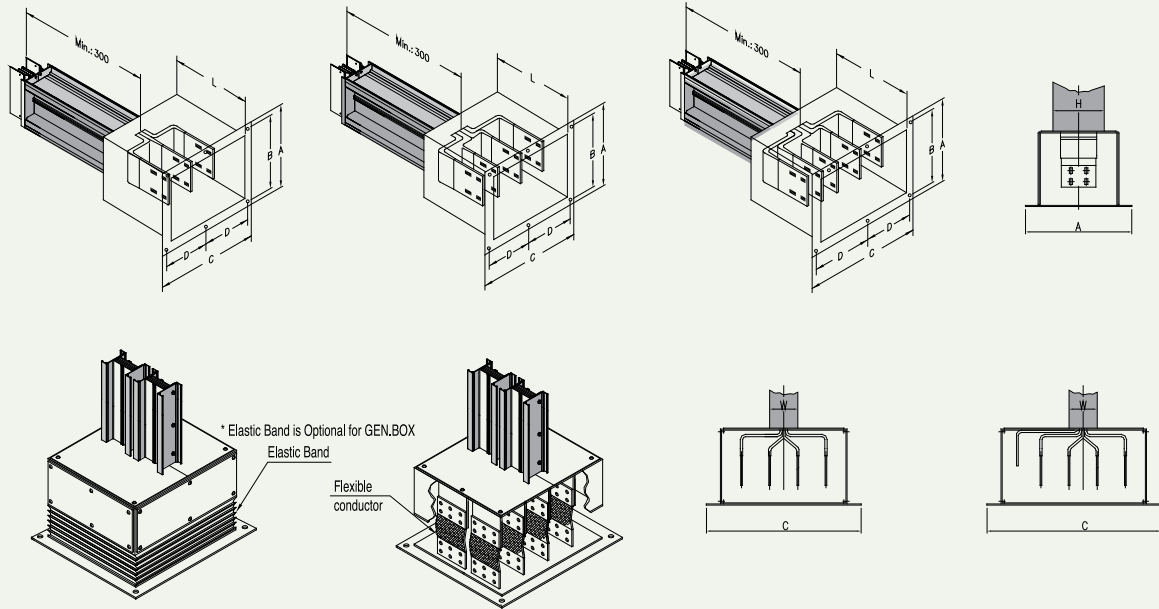

Rating(A)		3W, 4WGE	3W, 4WGE	3WGE	3WGE	3W, 4WGE	3W, 4WGE	4WGE	4WGE	4W+50%E/100%E			
60Hz	50Hz	AL	AL	AL, CU	AL, CU	CU	CU	AL, CU	AL, CU	AL/CU	AL/CU	AL, CU	AL, CU
		A	B	C	D	A	B	C	D	A	B	C	D
630	630	346	296	410	180	351	301	510	230	346/351	296/301	580	265
800	800	356	306	410	180	366	316	510	230	356/366	306/316	580	265
1,000	1,000	376	326	410	180	386	336	510	230	376/386	326/336	580	265
1,250	1,250	401	351	410	180	386	336	510	230	401/386	351/336	580	265
1,450	1,600	436	386	410	180	406	356	510	230	436/406	386/356	580	265
1,600	-	446	396	410	180	416	366	510	230	446/416	396/366	580	265
1,850	2,000	481	431	410	180	446	396	510	230	481/446	431/396	580	265
2,000	-	491	441	410	180	456	406	510	230	491/456	441/406	580	265
2,250	-	516	466	410	180	476	426	510	230	516/476	466/426	580	265
2,500	2,500	596	546	470	210	566	516	600	275	596/566	546/516	670	310
2,900	3,200	666	616	470	210	606	556	600	275	666/606	616/556	670	310
3,200	-	686	636	470	210	626	576	600	275	686/626	636/576	670	310
3,700	4,000	756	706	470	210	686	636	600	275	756/686	706/636	670	310
4,000	-	776	726	470	210	706	656	600	275	776/706	726/656	670	310
4,500	-	826	776	470	210	746	696	600	275	826/746	776/696	670	310
	5,000	926	876	470	210	836	786	600	275	926/836	876/786	670	310
5,000	-	986	936	470	210	881	831	600	275	986/881	936/831	670	310
5,800	6,300	1061	1011	470	210	956	906	600	275	1061/956	1011/906	670	310
6,300	-	1136	1086	470	210	1016	966	600	275	1136/1016	1086/966	670	310

Fittings

I-Series Busduct has a wide range of fittings to satisfy any layout of buildings. Elbow angles other than 90° are also available. Fitting designs are shown in the following figures, and they consist of the source-side and the load-side. Offset or combination elbows can be used where standard elbows are not feasible. (Dimensions for each fitting are shown in the following figures. Contact our design team for a minimum dimension.)

Elbow

[Horizontal]

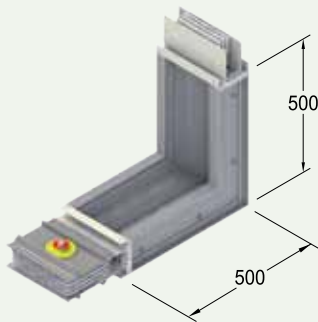

[Vertical]

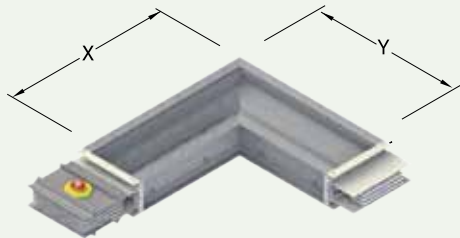

Offset

[Horizontal]

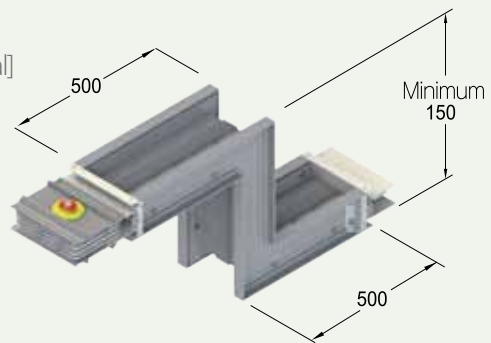

[Vertical]

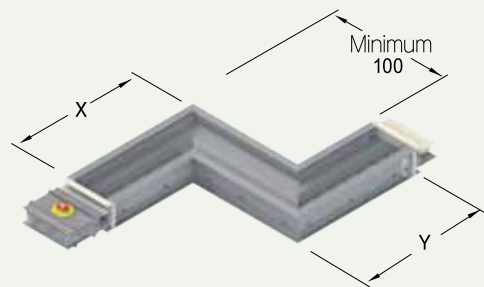

Vertical Elbow

	Ampere(A)	Dimension(mm)	
		X	Y
AL	630~1,450	500	500
	1,600~2,900	600	600
	3,200~4,000	700	700
	4,500~5,000	800	800
	5,800~6,300	900	900
CU	630~2,000	500	500
	2,250~3,700	600	600
	4,000~5,000	700	700
	5,800~6,300	800	800

Vertical Offset

	Ampere(A)	Dimension(mm)		
		X	Y	Z
AL	630~1,450	500	150	500
	1,600~2,900	600	150	600
	3,200~4,000	700	150	700
	4,500~5,000	800	150	800
	5,800~6,300	900	150	900
CU	630~2,000	500	150	500
	2,250~3,700	600	150	600
	4,000~5,000	700	150	700
	5,800~6,300	800	150	800

Combination

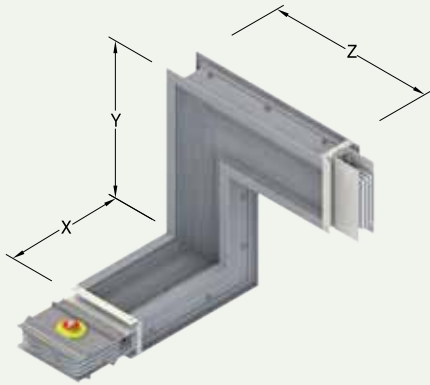

Rating(A)		Dimension(mm)		
		X	Y	Z
AL	630~1,450	500	500	500
	1,600~2,900	600	600	600
	3,200~4,000	700	700	700
	4,500~5,000	800	800	800
	5,800~6,300	900	900	900
CU	630~2000	500	500	500
	2,250~3,700	600	600	600
	4,000~5,000	700	700	700
	5,800~6,300	800	800	800

Tee

[Horizontal]

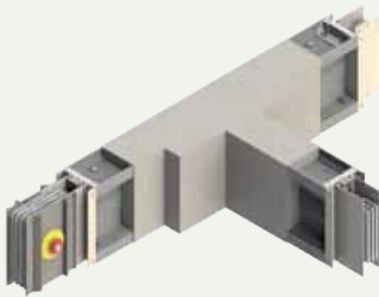

[Vertical]

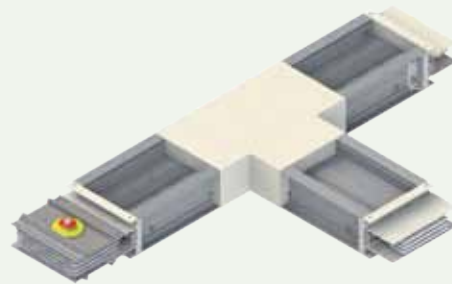

T/R Connection Feeder



Fittings

Expansion

The fitting is designed to allow a 60mm extension of a straight line.

Rating	Standard Dimension(mm)	
	X	Y
630~6,300A	1,500	360

*Flexible bars installed inside

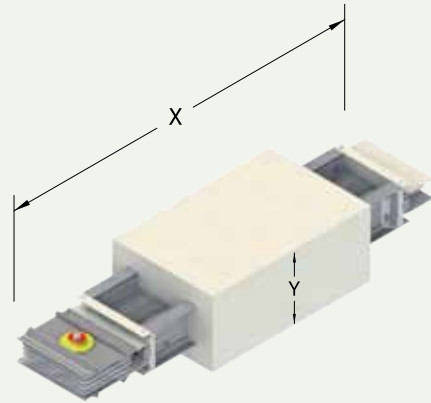

Reducer

A reducer is used to connect a large capacity busduct to a small capacity busduct. It can be used for an economical setup to distribute loads.

*Any change made to load distribution or to capacities follows electricity regulations.



Reducer Box

If an overcurrent breaker needs to be mounted on the reducer by customer request, it is possible to use the reducer box.



Phase Transposition Feeder

A phase transposition feeder is used when the setup transforms the phase.

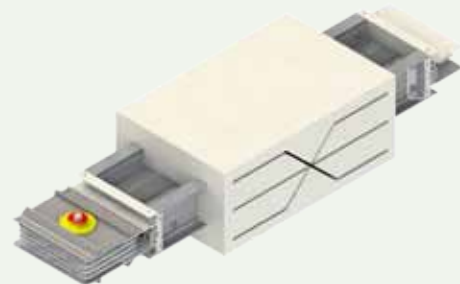

Hanger

Vertical Mounting Hangers

Spring hangers are used to support the busducts between floors. The number of springs depends on the weight of the installed busduct and plug-in boxes. A medium hanger should be installed if the height between the floors exceeds 4.5 meters, and the height of the installed spring hangers can be easily adjusted. Rigid hangers (no spring type) are used on the lowest floor, and they can be used instead of spring hangers depending on the set up design.

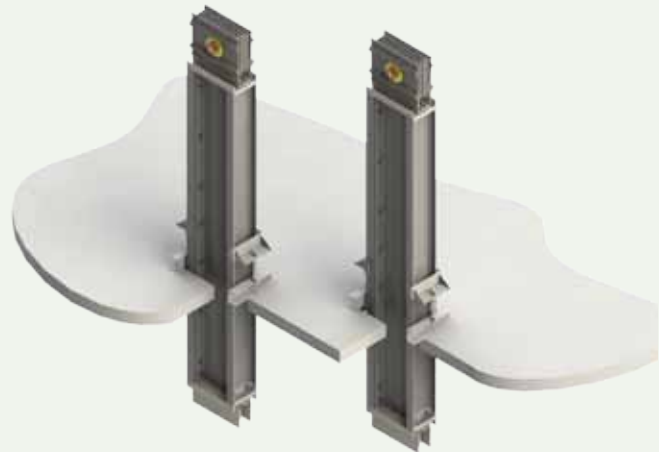

[Rigid Hanger]

[Spring Hanger]

Rigid Hanger

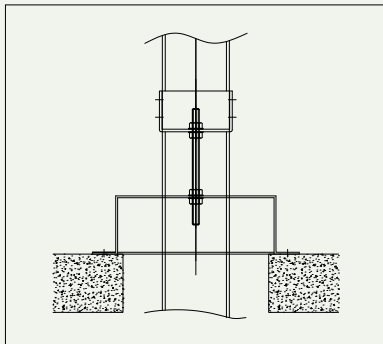

[1 Row]

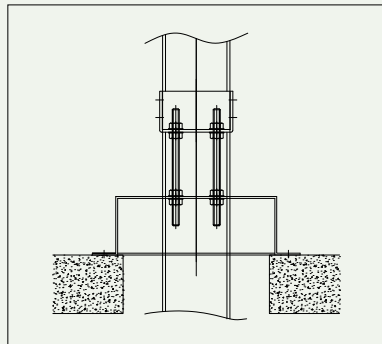

[2 Row]

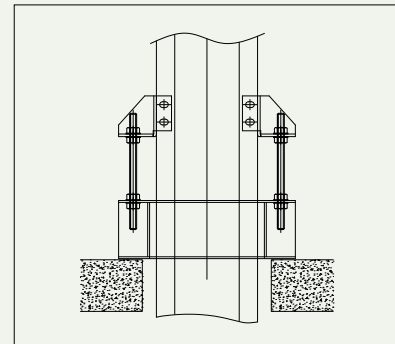

[Side View]

Spring Hanger

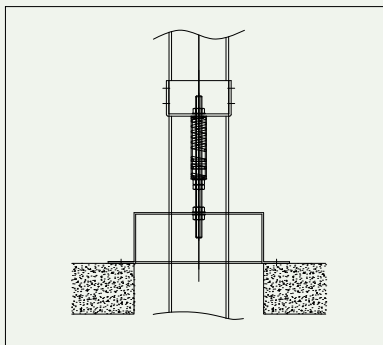

[1 Row]

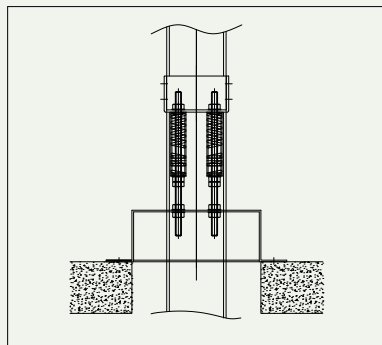

[2 Row]

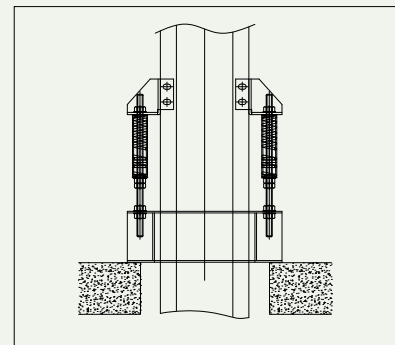

[Side View]

* Hangers with more than 2 rows depending on the installation environment are also available on request. Please contact the design team for further information.

Hanger

Horizontal Hangers

General Hangers

The standard installation method for these hangers is to install them horizontally at 1.5 meters intervals. They generally require 12mm diameter stud bolts.

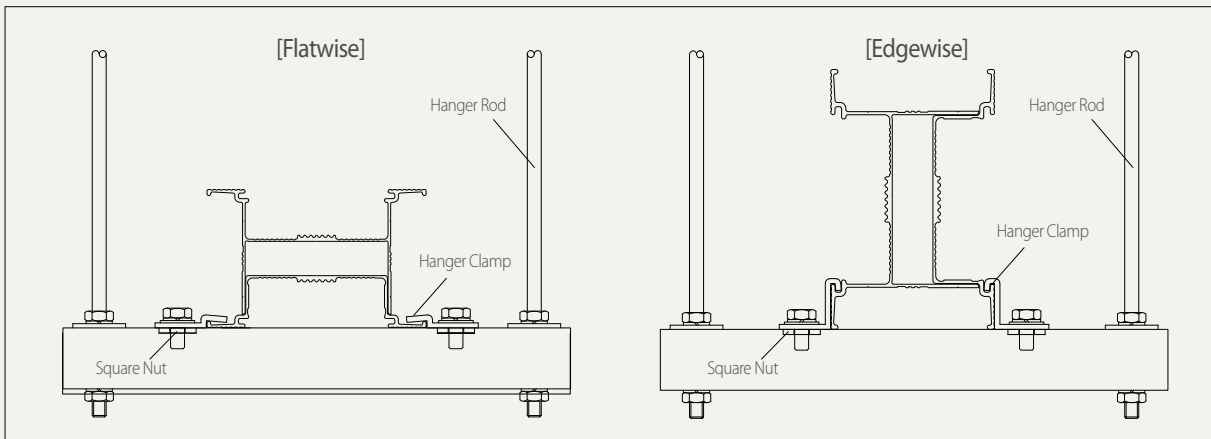

Wall Bracket

Wall brackets can be installed on a wall where general hangers are not feasible.

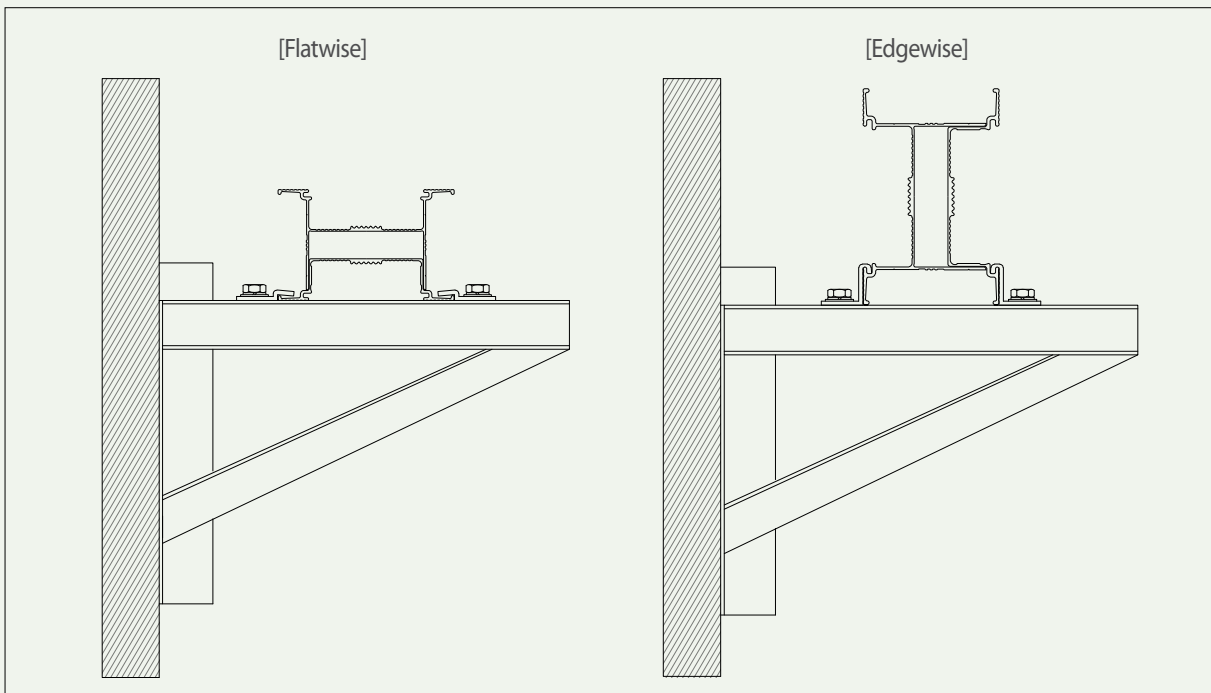

Plug-in Unit

Straight Lengths: Plug-in / Tap-off Intervals

This busduct comes with an overcurrent blocking device (MCCB, fuse) in order to protect the wires while distributing loads. The required minimum intervals of a plug-in(800A or less) and a tap-off(1000A, 1250A, 1600A) are shown below. A length longer than the required minimum intervals can be predestinated on request.

Plug-in Feeder

MCCB Frame (AF)	Plug-in Hole Intervals(P) (mm)
50, 125, 250	650
400	900
630, 800	1,000
1000, 1250	1,300

Plug-in Box

MCCB Frame (AF)	Dimensions(mm)				Fig.
	W		D	H	
125	200	230	200	360	E5-1
250	200	230	200	360	
400	230	280	200	800	
630, 800	300	370	200	800	
1000, 1250, 1600	400	450	230	1200	E5-2

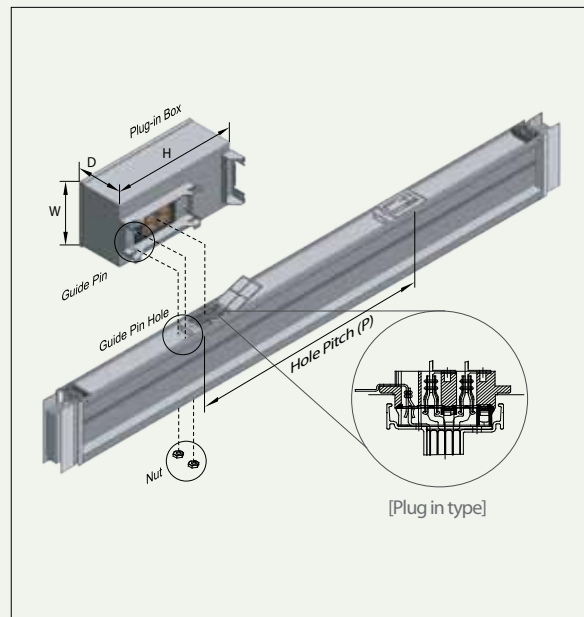

[Fig. E5-1]

Inspection Pin

This pin is used to check the insertion of the box.
*Available from 400AF box



[Before]

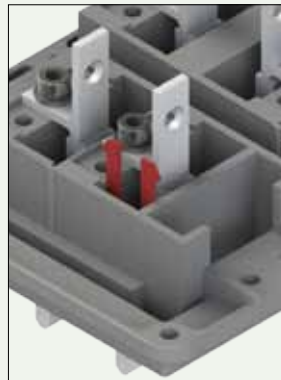

[After]

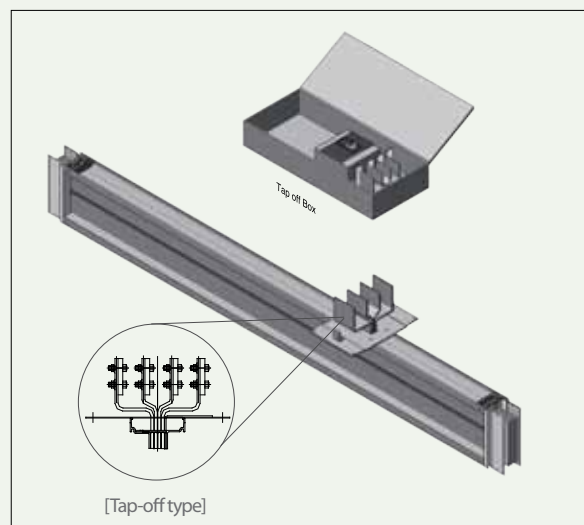

[Fig. E5-2]

Plug-in Unit

Plug-in Box Attachments

Attachments such as CT,TD and PT can be installed in a plug-in box to control and to supervise the current, voltage and wattage remotely.

Door Types of the Plug-in Unit

Various design of doors for the plug-in box is available to satisfy the demands of our clients. The available types are shown below.

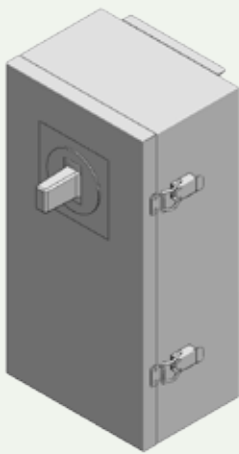

External handle

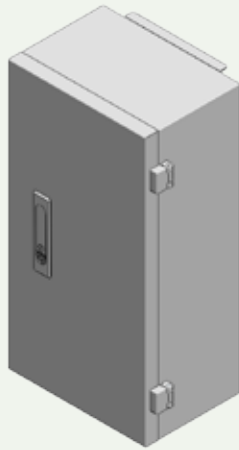

Push Button

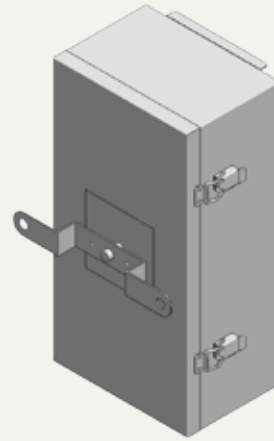

External lever interlock



Bolt Fastening

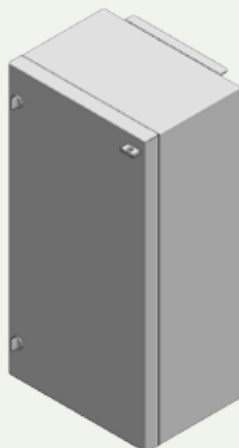

Key Lock



Outlet

Etc.

Wall Flange

A wall flange is used to seal the gaps produced during installation of busducts at the walls, ceilings and floor. The standard dimensions of a wall opening should be 30mm larger than the external dimensions of the I-Series Busduct.

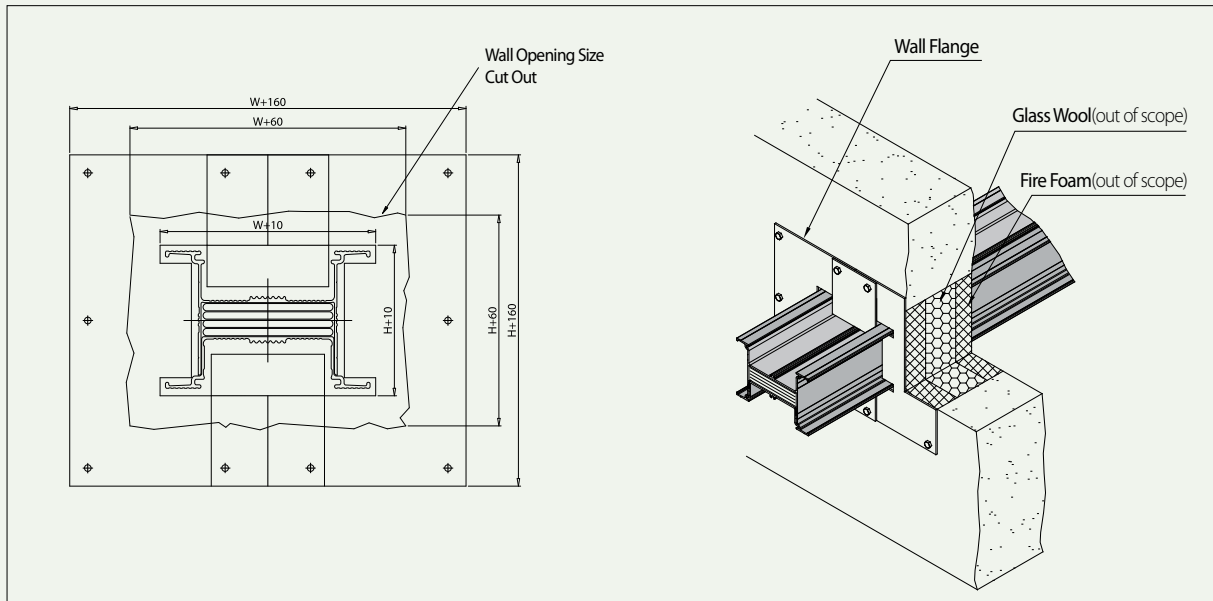

Component

Floor Openings

The standard dimensions of a floor opening should be 30mm larger than the external dimensions of the I-Series Busduct.

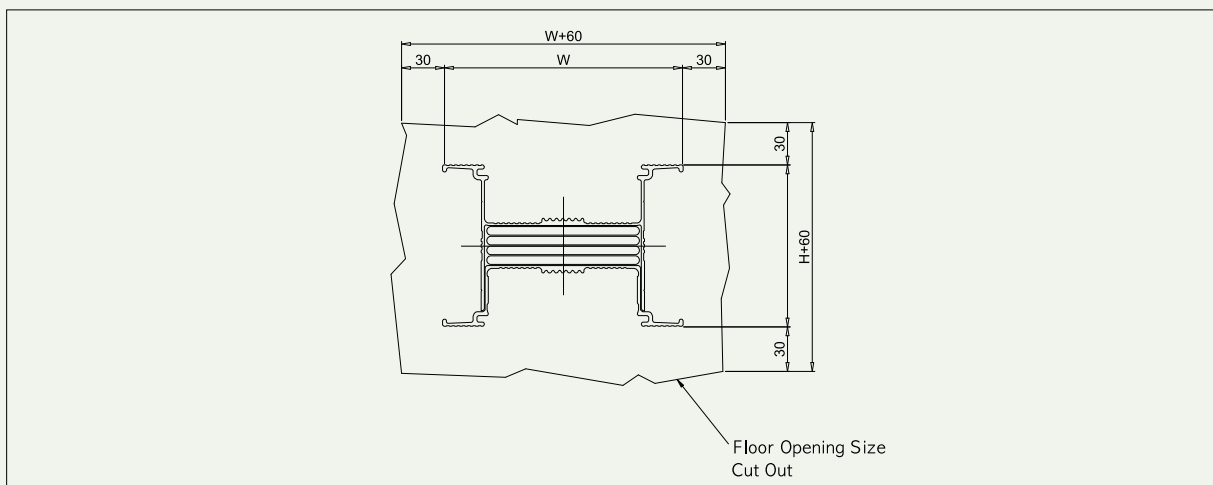

Etc.

The Required Minimum Distances from a Wall for Heat Dissipation and Maintenance

The required minimum distances between a busduct and a wall, or a ceiling are shown below.

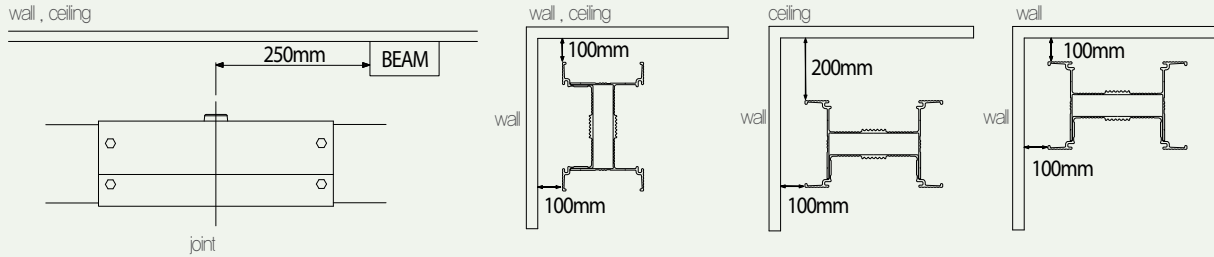

The required minimum distances between busducts

The required minimum distances between busducts are shown below.

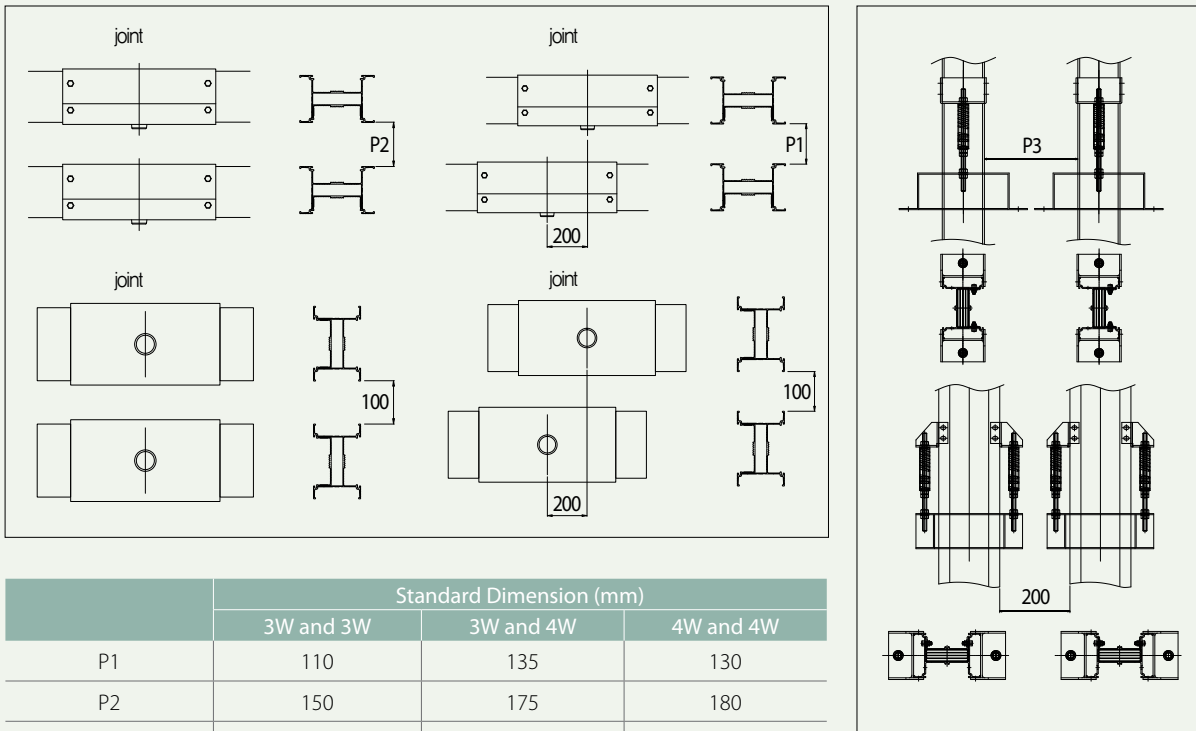

	Standard Dimension (mm)		
	3W and 3W	3W and 4W	4W and 4W
P1	110	135	130
P2	150	175	180
P3	190	215	230

* Outdoor installation requires a further discussion with our design team about proper distance.

Technical Data (60Hz)

Impedance and Voltage Drop

The formula to measure the voltage drop of a busduct is shown below. The impedance and voltage drop values for aluminum and copper conductors are shown in the table below.

The values listed are measured between upper and middle lines at 60Hz.

$$V_d = I \times \sqrt{3(R \cos\theta + X \sin\theta)}$$

V_d = voltage drop[V] · I = rated road amperes[A] · R = resistance[Ω] · X = reactance[Ω] / \cos = power factor / \sin = reactive factor

$$\text{Actual voltage Drop} = \alpha \times V_d \times \frac{\text{Actual load current}}{\text{Rated load current}} \times \frac{\text{Actual length of the line (m)}}{100m}$$

· α (Load Constant) $\alpha = 1$, concentrated load
(a place such as an electrical room)

$\alpha = 0.5$, Distributed load
(a place such as a vertical section)



· **F**: Flanged End (panel connections)
· **P**: Plug-in Unit

	Ampere(A) (60Hz)	Impedance($10^{-3}\Omega$ /100m, 60Hz)			Voltage Drop(V/100m)			
		R (AC)	X	Z	0.7	0.8	0.9	1
AL	630	12.71	4.34	13.43	13.09	13.93	14.54	13.87
	800	10.05	3.30	10.58	13.01	13.88	14.53	13.93
	1,000	7.54	2.64	7.99	12.40	13.19	13.74	13.06
	1,250	5.60	1.08	5.71	10.17	11.11	11.94	12.13
	1,450	4.63	0.89	4.71	9.74	10.65	11.44	11.62
	1,600	3.74	1.47	4.02	10.16	10.73	11.10	10.37
	1,850	3.27	1.28	3.52	10.28	10.86	11.23	10.49
	2,000	2.86	0.99	3.03	9.40	9.99	10.42	9.91
	2,250	2.52	0.87	2.67	9.31	9.91	10.33	9.83
	2,500	2.72	1.04	2.92	11.47	12.14	12.58	11.80
	2,900	2.25	0.86	2.41	10.99	11.63	12.05	11.31
	3,200	1.87	0.64	1.97	9.76	10.40	10.85	10.35
	3,700	1.63	0.56	1.73	9.88	10.52	10.98	10.47
	4,000	1.37	0.69	1.53	10.03	10.43	10.60	9.46
	4,500	1.20	0.61	1.35	9.94	10.34	10.50	9.38
	5,000	1.07	0.36	1.13	8.76	9.33	9.75	9.30
5,800	0.93	0.31	0.98	8.79	9.36	9.78	9.33	
6,300	0.80	0.44	0.91	9.56	9.88	9.96	8.72	
CU	630	13.66	2.66	13.92	12.51	13.67	14.68	14.91
	800	10.24	2.44	10.53	12.34	13.38	14.24	14.19
	1,000	7.72	1.56	7.88	11.30	12.33	13.22	13.38
	1,250	4.75	2.03	5.17	10.34	10.87	11.18	10.29
	1,450	4.00	1.71	4.35	10.10	10.61	10.92	10.06
	1,600	3.57	1.22	3.78	9.35	9.96	10.39	9.91
	1,850	3.15	1.08	3.32	9.52	10.13	10.57	10.08
	2,000	2.61	1.14	2.84	9.13	9.59	9.84	9.03
	2,250	2.30	1.00	2.51	9.07	9.52	9.77	8.96
	2,500	2.36	1.00	2.57	10.25	10.78	11.10	10.24
	2,900	1.99	0.84	2.16	10.01	10.53	10.84	10.00
	3,200	1.78	1.06	2.07	11.10	11.41	11.43	9.85
	3,700	1.56	0.93	1.82	11.29	11.61	11.63	10.02
	4,000	1.21	0.82	1.46	9.90	10.09	10.00	8.36
	4,500	1.07	0.72	1.29	9.82	10.01	9.92	8.30
	5,000	1.03	0.57	1.17	9.75	10.08	10.16	8.91
5,800	0.86	0.47	0.98	9.42	9.74	9.82	8.61	
6,300	0.75	0.54	0.92	9.92	10.06	9.92	8.18	

Technical Data (50Hz)

The formula to measure the voltage drop of a busduct is shown below. The impedance and voltage drop values for aluminum and copper conductors are shown in the table below.

The values listed are measured between upper and middle lines at 50Hz.

$$V_d = I \times \sqrt{3}(R \cos\theta + X \sin\theta)$$

V_d = voltage drop[V] · I = rated road amperes[A] · R = resistance[Ω] · X = reactance[Ω] / \cos = power factor / \sin = reactive factor

$$\text{Actual voltage Drop} = \alpha \times V_d \times \frac{\text{Actual load current}}{\text{Rated load current}} \times \frac{\text{Actual length of the line (m)}}{100\text{m}}$$

· α (Load Constant) $\alpha = 1$, concentrated load
(a place such as an electrical room)

$\alpha = 0.5$, Distributed load
(a place such as a vertical section)

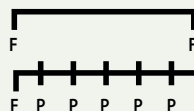

· **F** : Flanged End (panel connections)
· **P** : Plug-in Unit

Ampere(A) (50Hz)	Impedance($10^{-3}\Omega$ / 100m, 50Hz)			Voltage Drop(V/100m)				
	R (AC)	X	Z	0.7	0.8	0.9	1	
AL	630	12.22	3.04	12.60	11.71	12.66	13.45	13.34
	800	9.84	2.57	10.17	12.09	13.05	13.83	13.64
	1,000	7.12	1.97	7.39	11.08	11.92	12.59	12.34
	1,250	5.34	1.53	5.55	10.45	11.23	11.84	11.56
	1,600	3.90	1.73	4.27	11.00	11.53	11.82	10.81
	2,000	2.94	1.07	3.12	9.76	10.35	10.76	10.17
	2,500	2.67	0.76	2.77	10.44	11.22	11.83	11.54
	3,200	1.96	0.80	2.12	10.78	11.36	11.72	10.87
	4,000	1.45	0.70	1.61	10.51	10.96	11.17	10.06
	5,000	1.20	0.60	1.34	10.97	11.42	11.61	10.39
6,300	0.97	0.23	1.00	9.20	9.98	10.63	10.60	
CU	630	13.48	2.07	13.64	11.91	13.13	14.22	14.71
	800	10.18	1.72	10.32	11.58	12.72	13.74	14.11
	1,000	7.71	1.29	7.82	10.94	12.02	12.99	13.36
	1,250	4.77	1.57	5.02	9.66	10.30	10.78	10.33
	1,600	3.74	1.65	4.08	10.51	11.03	11.31	10.35
	2,000	2.65	1.32	2.96	9.69	10.09	10.26	9.19
	2,500	2.39	0.78	2.51	9.66	10.30	10.78	10.33
	3,200	1.93	0.73	2.06	10.35	10.96	11.36	10.67
	4,000	1.29	0.75	1.49	9.96	10.26	10.29	8.91
	5,000	1.16	0.21	1.18	8.32	9.12	9.83	10.05
6,300	0.85	0.76	1.14	12.36	12.34	11.90	9.22	

Technical Data (60Hz)

Short Circuit Strength

LS C&S Busduct has been tested under actual short circuit conditions according to IEC 61439-1 and 6 [(previous standard) IEC 60439-1 and 2] at KEMA and ASTA. The result and the graph are shown below.

Phase to Phase Short Circuit Ratings

Ampere(A) (60Hz)	AL (kA)			CU (kA)		
	1 sec	3 sec	Peak	1 sec	3 sec	Peak
630	25	14	52.5	20	12	40
800	25	14	52.5	20	12	40
1,000	50	29	105	35	20	73.5
1,250	65	38	143	50	29	105
1,450	65	38	143	50	29	105
1,600	65	38	143	65	38	143
1,850	65	38	143	65	38	143
2,000	80	46	176	80	46	176
2,250	80	46	176	80	46	176
2,500	100	58	220	105	61	231
2,900	100	58	220	105	61	231
3,200	100	58	220	105	61	231
3,700	100	58	220	105	61	231
4,000	100	58	220	105	61	231
4,500	100	58	220	105	61	231
5,000	120	69	254	120	69	254
5,800	120	69	254	120	69	254
6,300	120	69	254	120	69	254

* Reinforced type available

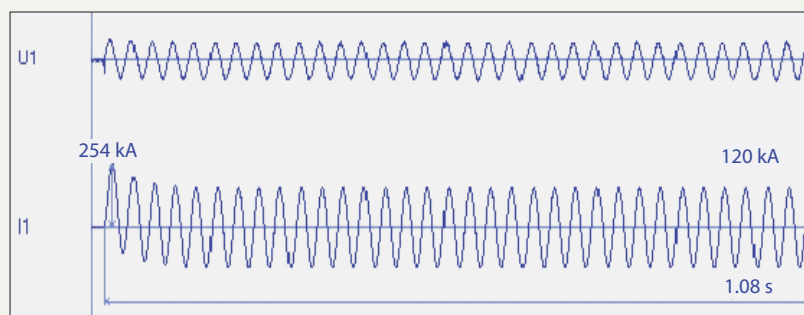

Technical Data (50Hz)

Short Circuit Strength

LS C&S Busduct has been tested under actual short circuit conditions according to IEC 61439-1 and 6 [(previous standard) IEC 60439-1 and 2] at KEMA and ASTA. The result and the graph are shown below.

Phase to Phase Short Circuit Ratings

Ampere(A) (50Hz)	AL (kA)			CU (kA)		
	1 sec	3 sec	Peak	1 sec	3 sec	Peak
630	25	14	52.5	20	12	40
800	25	14	52.5	20	12	40
1,000	50	29	105	35	20	73.5
1,250	65	38	143	50	29	105
1,600	65	38	143	50	29	105
2,000	65	38	143	65	38	143
2,500	100	58	220	105	61	231
3,200	100	58	220	105	61	231
4,000	100	58	220	105	61	231
5,000	100	58	220	105	61	231
6,300	120	69	264	120	69	264

* Reinforced type available

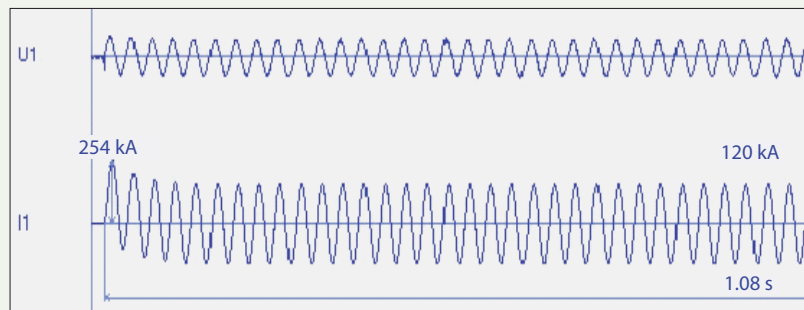

Temperature Rise

The temperature rise limit is an important property which determines the performance of busducts. The temperature rise limit of the busduct is designed that when a busduct is operated with a rated current, the temperature limit values of the housing are within 55K as specified in IEC61439-1 and 6 [(previous standard) IEC 60439-1 and 2].

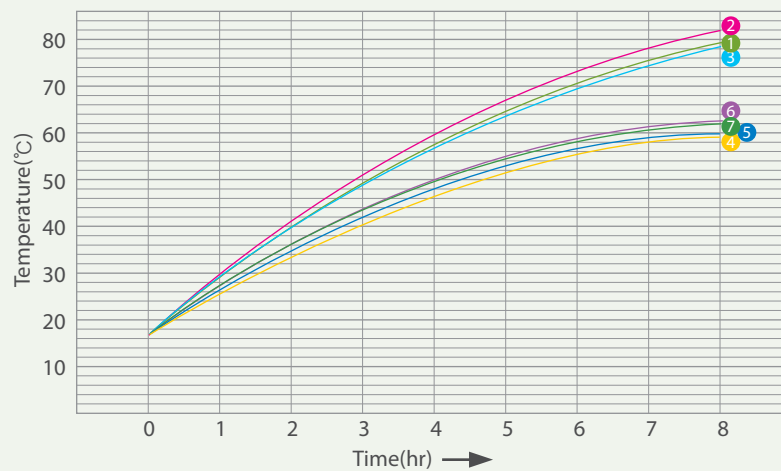
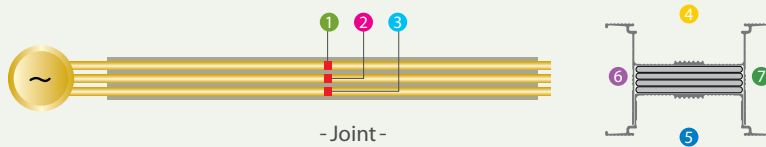

Joint Connection

Joint KIT

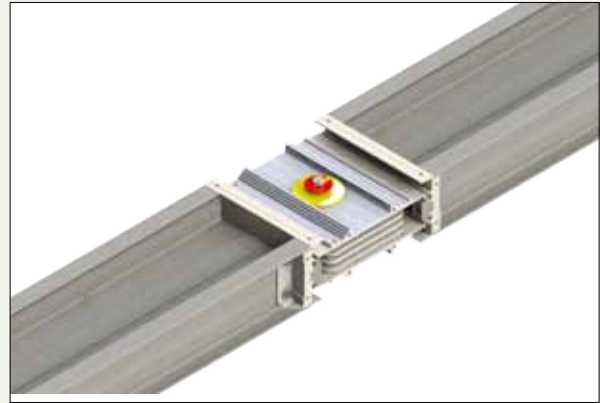
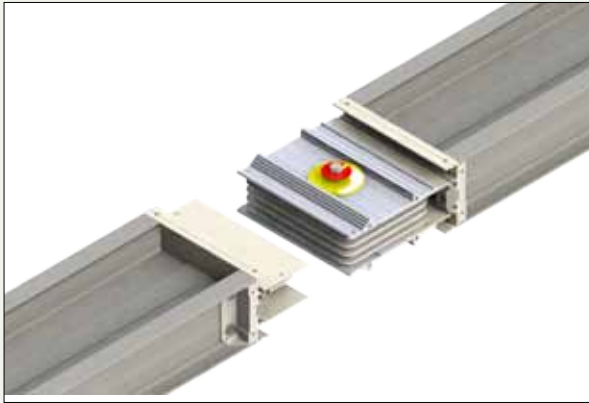

Both parts should be aligned at the top and the bottom and the left and the right as well as horizontally and vertically. (This also applies to the joint connection of the horizontal and vertical ducts.) Make sure that the joint kit is not tilted. (We recommend a jig tool for the installation.)

Using a torque wrench, slowly tighten the exposed bolt head of a double headed bolt. The head of the double headed bolt is designed to break off at 800~1000Kgf·cm. Continue tightening the exposed head until it breaks off.

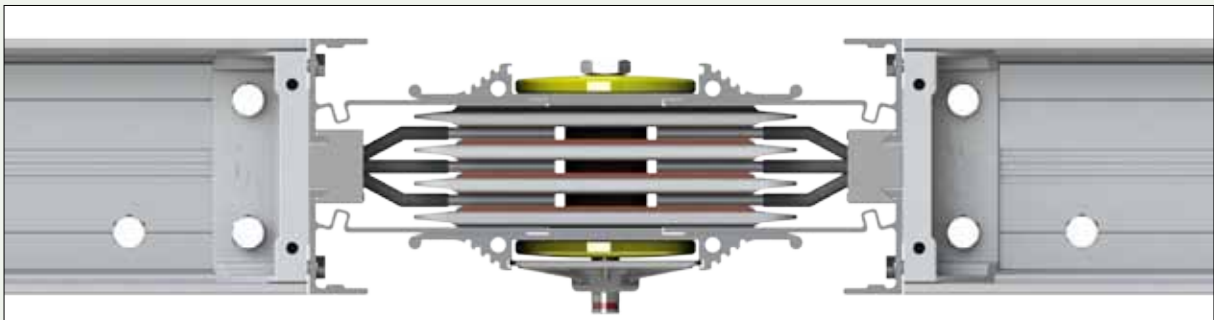

Once the exposed head and the red tag attached to it have been cut off, a red line should be visible, which means they are properly connected. Be sure to check the distance from the housing, and the gaps between the conductors at the kit after the installation.

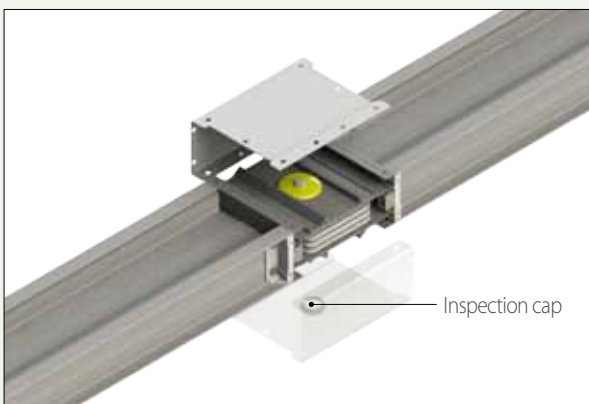

Before applying the connection cover, check the space between the end block and the holes of the connection cover. The red line should be visible through the transparent cap.

Perform the last inspection of the connection.

Certification & Specification



KEMA KEUR (I-Series AL-AL)



KEMA KEUR (I-Series CU-AL)

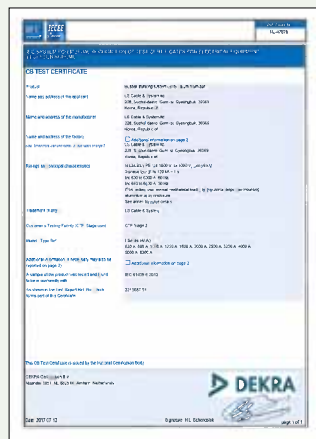

CB Certificate (I-Series AL-AL)

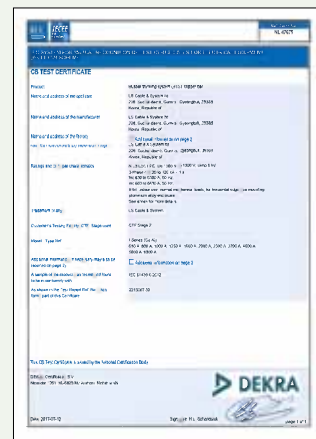

CB Certificate (I-Series CU-AL)



ISO 9001



ISO 14001



OHSAS 18001

Install Information

Certification & Specification

Global Network

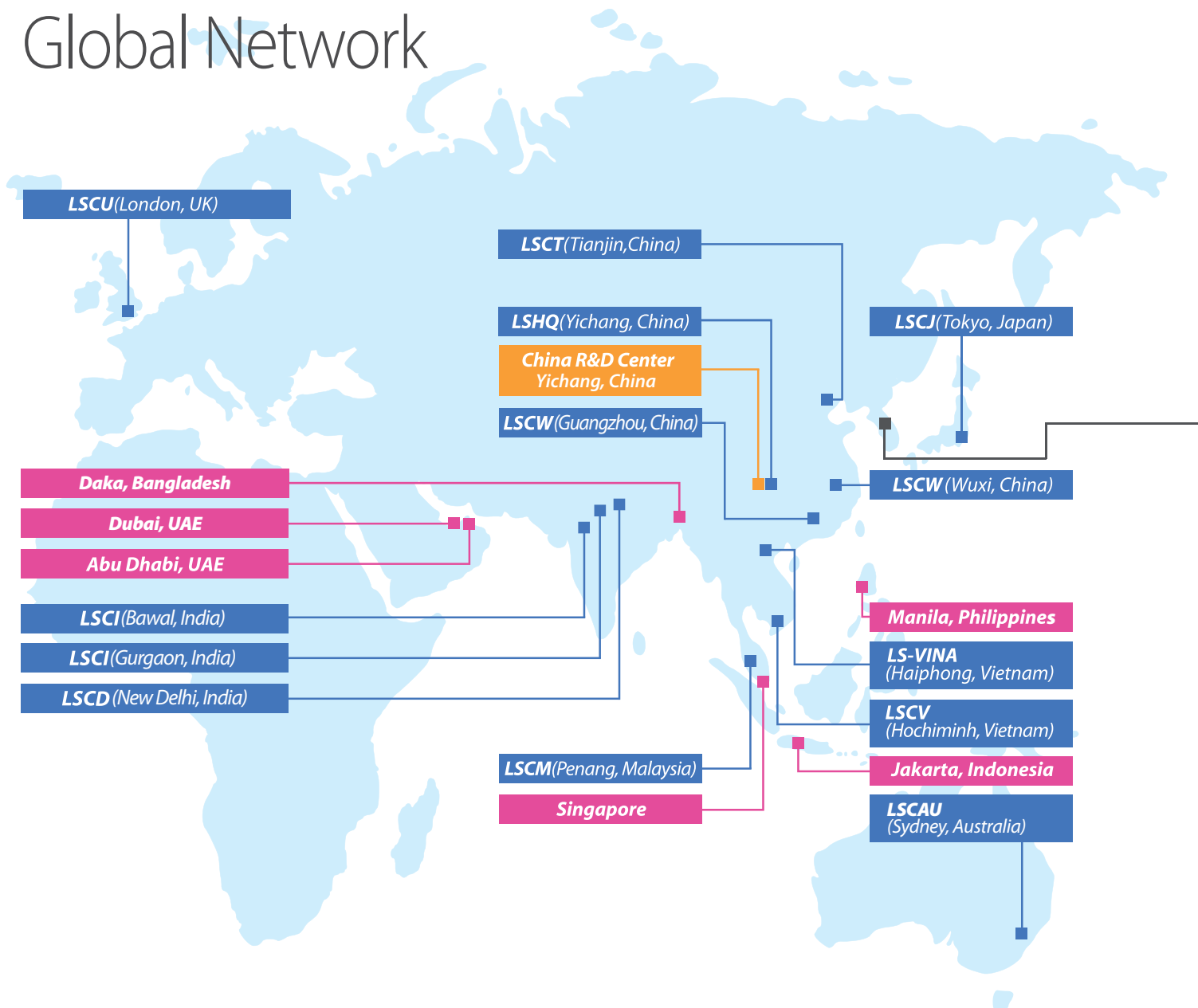

Branches

Abu Dhabi Office(U.A.E.)

Tel. +971-4-344-4662 Fax. +971-2-674-8781

Dubai Office(U.A.E.)

Tel. +971-4-344-4662 Fax. +971-2-674-8781

Singapore Office(Singapore)

Tel. +65-6342-9162-3 Fax. +65-6342-9165

Lima Office(Peru)

Tel. +51-1-434-6433

Jakarta Office(Indonesia)

Tel. +62-21-797-4140 / 4013 Fax. +62-21-799-3071

Manila Office(Philippines)

Tel. +63-917-6272814

Daka Office(Bangladesh)

Tel. +88-015-3410-0356

Subsidiaries

LSCA(U.S.A.) : Marketing and Sales

Tel. +1-201-944-2005 Fax. +1-201-503-8130

LSCAU(Australia) : Marketing and Sales

Tel. +61-2-9460-0255 Fax. +61-2-9460-0355

LSCU(U.K.) : Marketing and Sales

Tel. +44-20-8545-2640 Fax. +44-20-8545-2643

LSCJ(Japan) : Marketing and Sales

Tel. +81-3-6205-7188 Fax. +81-3-6205-7187

LSCD(India) : Marketing and Sales

Tel. +91-11-4106-4242

LSHQ(China)

Tel. +86-717-667-7777

Production : EHV, LV/MV, Overhead Transmission Line, Industrial Specialty Cable & System

LSCT(China)

Tel. +86-22-2699-7618 Fax. +86-22-2695-7617

Production : Magnet Wire

LSCW(China)

Tel. +86-510-8811-9000 Fax. +86-510-8534-5341

Production : Automotive Wire & Cable, Bus Duct, Electronic Wire & Cable, Tube, ACF, Accessories for EHV Cable System

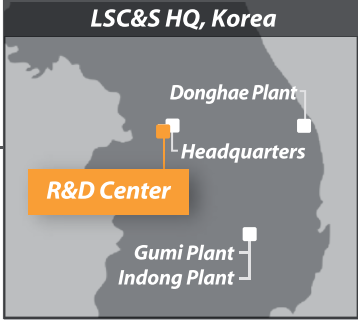
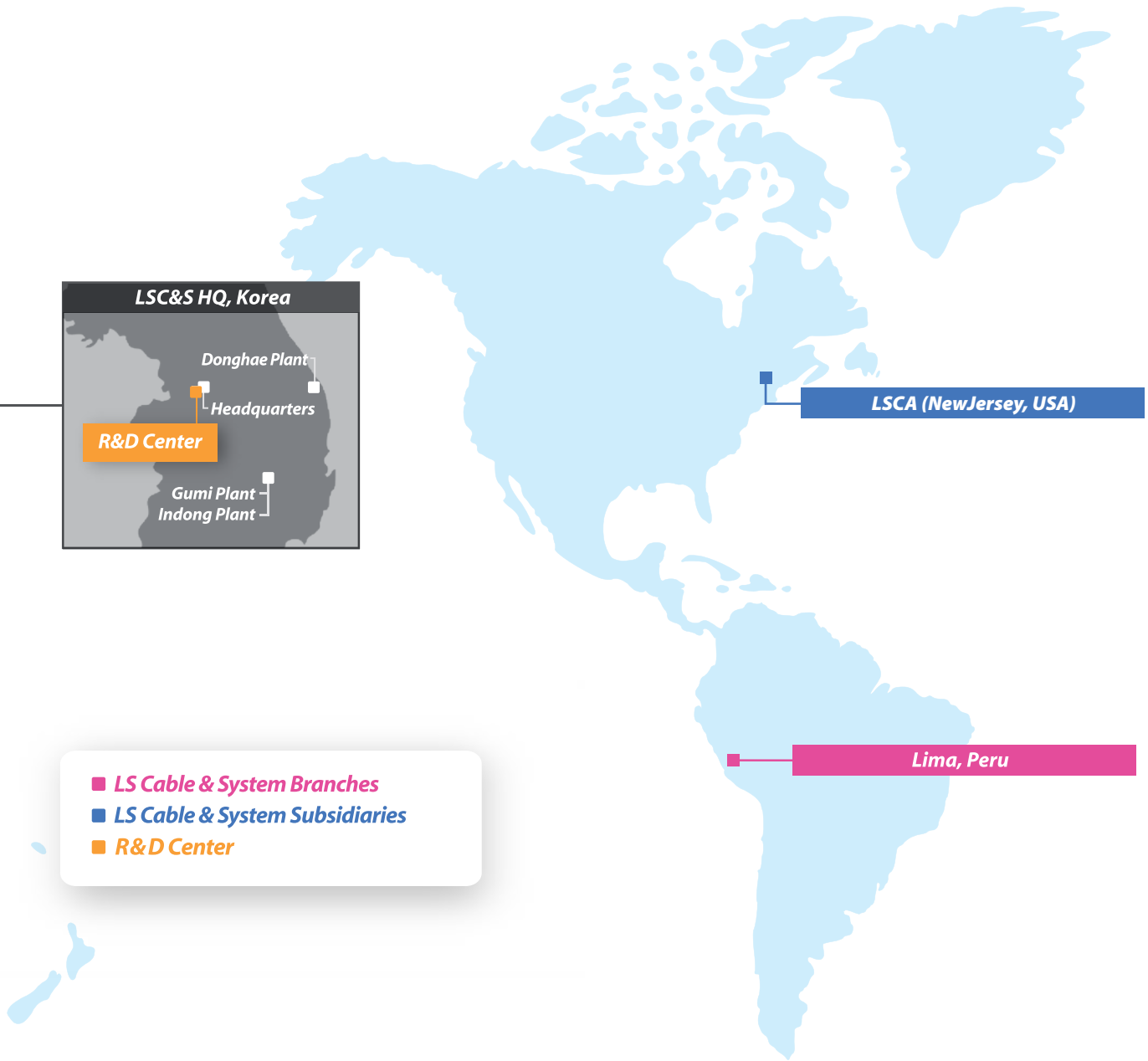

- **LS Cable & System Branches**
- **LS Cable & System Subsidiaries**
- **R&D Center**

Beijing Office(Beijing)

Tel. +86-10-5761-3166 Fax. +86-10-5761-3160

Shenzhen Office(Shenzhen)

Tel. +86-755-8275-0470~1 Fax. +86-755-8275-0545

Guangzhou Office(Guangzhou)

Tel. +86-20-8326-6321 Fax. +86-20-8326-6270

LS-VINA(Vietnam)

Tel. +84-31-354-0141 Fax. +84-31-354-0142

Production : EHV, LV/MV, ACSR, OPGW, SCR

LSCV(Vietnam)

Tel. +84-61-356-9140 Fax. +84-61-356-9148

Production : Low Voltage Cable, UTP

LSCM(Malaysia)

Tel. +60-4-588-9609 Fax. +60-4-588-9607

Production : Magnet Wire

LSCI(India)

Gurgaon: Marketing & Sales

Tel. +91-124-428-5800~4 Fax. +91-124-428-5805

Bawal

Tel. +91-128-426-4267 Fax. +91-128-426-4364

Production : RF Feeder Cable, Network Solution, EHV, LV/MV, OPGW

China R&D Center

Tel. +86-717-667-7777

Korea Operations

Headquarter

Tel. +82-2-2189-9114

Gumi Plant

Tel. +82-54-469-7114

Production : Power Cable up to 500kV, OHTL, OPGW, Data Cable, RF Feeder System, Copper Rod, Magnet Wire

Indong Plant

Tel. +82-54-469-1053

Production : Industrial Cable & Module, Optical Cable, Aluminum Materials

Donghae Plant

Tel. +82-33-820-3114

Production : Submarine Cable, Industrial Specialty Cable

R&D Center

Tel. +82-31-450-8114

Greater Value Together
LS Cable & System

LS Cable & System
www.lscns.com

LS Busduct System

12F, LS Tower, 127 LS-ro, Dongan-gu, Anyang-si, Gyeonggi-do, 14119, Korea
Tel. +82-2-2189-9669 Fax. +82-2-6969-5424

©2019 LS Cable & System Ltd. All right reserved. This product or document is protected by copyright and distributed under licenses restricting its use, copying, distribution, and decompilation. No part of this product or document may be reproduced in any form by any means without prior written authorization of LS Cable & System and its licensors, if any. Products shown on this catalog are subject to change without any prior notice.